

GEMINI 1X1 HARD



www.litepanels.com

SAFETY INFORMATION



To clean the GEMINI 1X1 HARD, wipe with a clean, dry, non-abrasive cloth only.

Weight (including Yoke, not including accessories): 6.0 kg [13.25 lb]

Dimensions (including Yoke, not including accessories): W = 40.7 cm [16.0 in], H = 47.0 cm [18.5 in], D = 11.8 cm [4.7 in]

Do not restrict air flow around the GEMINI 1X1 HARD. Keep the fixture's air intakes and air exhaust space clear of obstruction.

Plug the GEMINI 1X1 HARD into a mains electrical outlet using only a provided AC IEC Power Cable or one specified by Litepanels®. Protect the cable from pinching, twisting, or crushing. Use a mains electrical outlet that is grounded and rated for 100-240VAC, 50/60Hz only.

Do not use, mount, transport, or store the GEMINI 1X1 HARD near radiators, space heaters, ovens, stoves, heat registers, open flame, or any heat source, or in an environment with an ambient temperature greater than 65°C [149° F].

The GEMINI 1X1 HARD is suitable for operation only in an environment as follows: ambient air temperature between -20°C and 45°C [between -4°F and 113°F]; less than 85% relative humidity (RH), no condensation. Use in a dry environment; do not place on a wet surface or submerge the GEMINI 1X1 HARD in liquid.

WARNING: Tampering with or disassembling the GEMINI 1X1 HARD may result in electric shock and will void the manufacturer's warranty.

WARNING: To reduce the risk of electric shock or fire, do not expose the GEMINI 1X1 HARD to rain, moisture, or liquids.

Immediately consult with qualified Litepanels® service personnel if any of the following have occurred: The fixture has been dropped or impacted; the power cable has been damaged; the fixture has been exposed to rain, moisture, or liquid; or the fixture does not operate normally.

This device complies with Part 15 of the FCC Rules. Operation is subject to the following two conditions: (1) this device may not cause harmful interference, and (2) this device must accept any interference received, including interference that may cause undesired operation.

INCLUDED

GEMINI 1X1 HARD Lensed LED Fixture
GEMINI 1X1 HARD Yoke

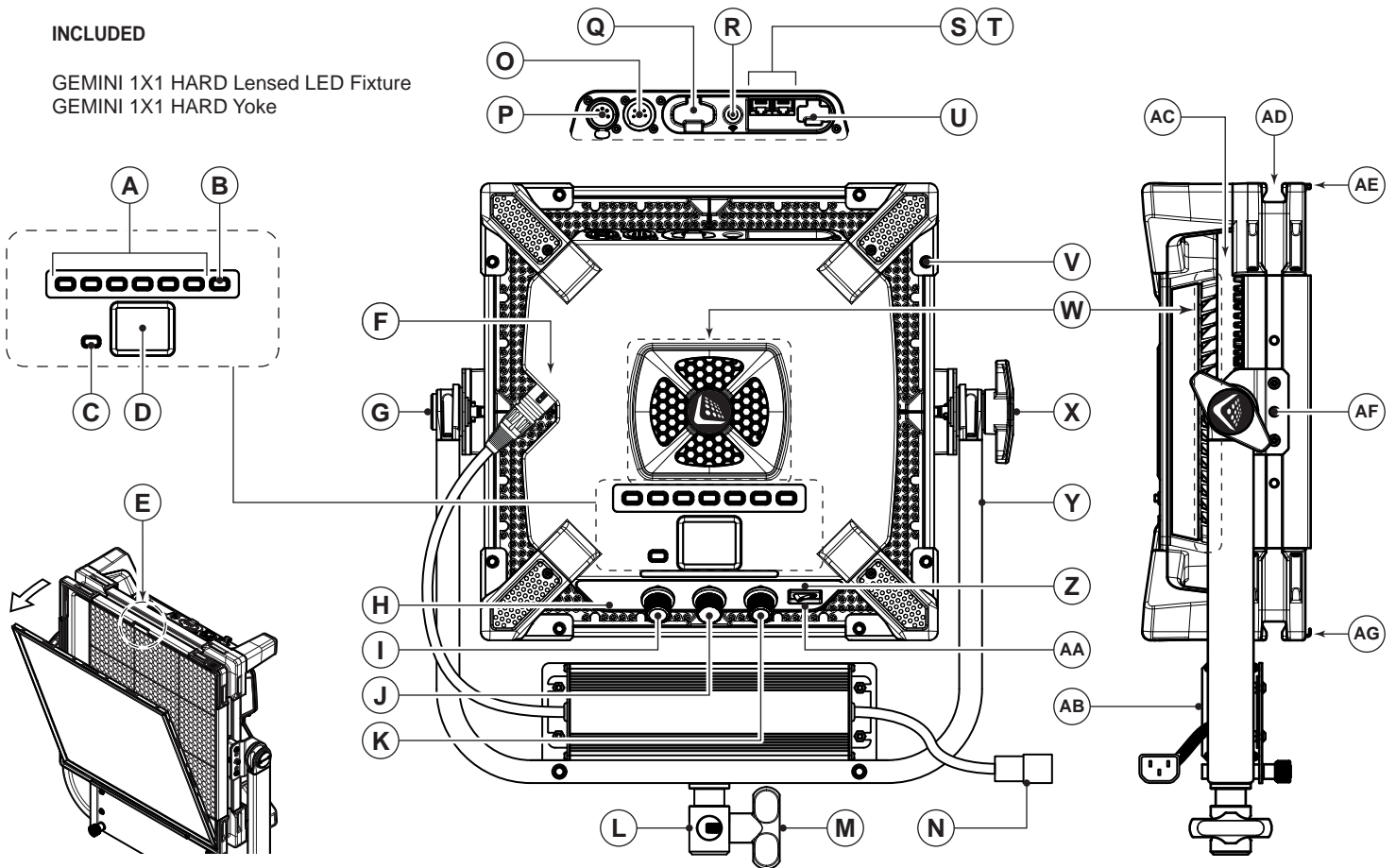

- | | | |
|--|---|---|
| <ul style="list-style-type: none"> (A) PRESET BUTTONS (6X) (B) PRESET TOGGLE BUTTON (C) CANCEL BUTTON (D) DISPLAY (E) DIFFUSER RELEASE NOTCH (F) 3-PIN XLR DC POWER INPUT JACK (G) TILT LOCK SCREW (H) ACTIVE COMMS INDICATOR LIGHT (I) GREEN OFFSET / HUE / MENU KNOB (J) CCT / SATURATION KNOB (K) DIMMER / INTENSITY KNOB (L) TVMP BABY PIN STAND ADAPTER | <ul style="list-style-type: none"> (M) TVMP PAN LOCK KNOB (N) IEC AC INPUT (O) 5-PIN XLR DMX / MASTER/REPLICA INPUT (P) 5-PIN XLR DMX / MASTER/REPLICA OUTPUT (Q) BLUETOOTH® / WIRELESS DMX PORT (R) ANTENNA (S) RJ45 DMX / MASTER/REPLICA OUTPUT (T) RJ45 DMX / MASTER/REPLICA INPUT (U) USB PORT (V) 1/4-20 FEMALE THREAD (8X) (W) AIR INTAKE (X) YOKE TILT LOCK KNOB | <ul style="list-style-type: none"> (Y) YOKE (Z) POWER / STATUS INDICATOR LIGHT (AA) ON / OFF SWITCH (AB) POWER SUPPLY ADAPTER (AC) AIR EXHAUST SPACE (AD) DOVETAIL CHANNEL (4X) (AE) ACCESSORY LATCH (AF) YOKE LOCKING PIN (2X) (AG) ACCESSORY RAIL (3X) |
|--|---|---|

SEE REVERSE

SETUP

Mount the GEMINI 1X1 HARD with its included Yoke (see "Y" above) and TVMP Baby Pin Stand Adapter ("L") to a rigging or support system rated for the weight of the fixture and its accessories (not included). **Ensure that the two Yoke Locking Pins ("AF") are set and fully tightened.** Always comply with applicable local regulations. Use supplemental safety equipment (e.g. safety chain or cable, not included) as required.

Remove the included diffuser by pulling it out at the Diffuser Release Notch ("E"). Install a diffuser by pressing it in until it snaps into place fully.

WARNING: Keep the air intakes ("W") and the air exhaust space ("AC") clear of blockage. Allow more than 25 cm [10 inches] of clear air space from the rear of the GEMINI 1X1 HARD to the nearest obstruction. Use only covers and accessories approved by Litepanels®, and ensure that they do not obstruct the air intakes or exhaust.

Ensure that the Power Supply Adapter ("AB") is plugged into the fixture via the 3-Pin XLR DC Power Input Jack ("F") (33 VDC MAX). Connect the power supply adapter to the AC power cable (not pictured) at the IEC AC Input ("N"). Use only a provided AC power cable. Plug the power cable into a mains power outlet. Switch the ON / OFF Power Switch ("AA") to the "ON" position. The GEMINI 1X1 HARD is ready for operation.

For information on customizing effects or controlling the GEMINI 1X1 HARD via DMX, refer to the Litepanels GEMINI Effects Details or DMX Map at www.litepanels.com

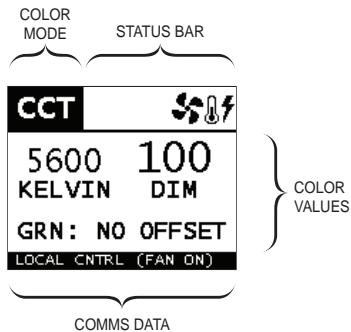

COLOR MODES

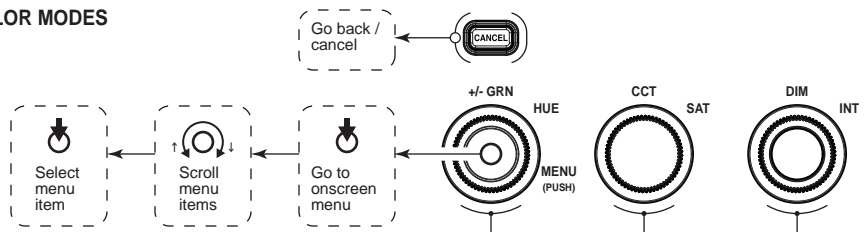

CCT MODE
(Default)

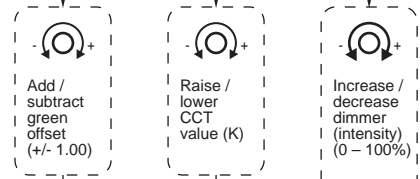
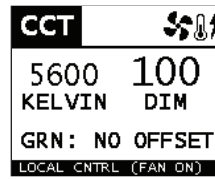

HSI MODE

Go to onscreen menu
COLOR MODE
→ HSI MODE

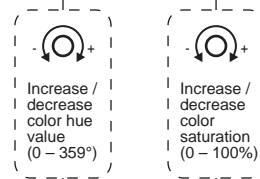

GEL MODE

Go to onscreen menu
COLOR MODE
→ GEL MODE

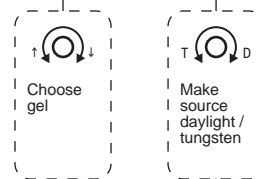

RGBW MODE

Go to onscreen menu
COLOR MODE
→ RGBW MODE

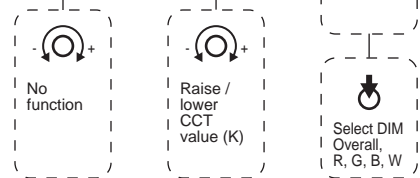

TROUBLESHOOTING

Behavior	Power/Status Indicator	Condition	Recommended Action
There is no light output.	green solid on	Fixture is operating normally.	Adjust dimmer knob to change brightness.
Power/Status Indicator flashes green when fixture is powered on.	green flashes	Fixture is operating normally.	Take no action. The green flashing stops shortly after the fixture has been powered on.
Light turns off.	red solid on	Input Over Voltage Fault	Turn fixture off; change power source.
Light turns off.	red solid on	Input Under Voltage Fault	Turn fixture off; change power source.
Light is on.	red flash, pause, (repeat)	Input Under Voltage Warning	Change power source.
Light is on.	red flashes (2X), pause, (repeat)	Over Temperature Warning	Turn the dimmer down to 0% and allow fixture to cool. Check fan and vents.
Light turns off.	red flashes (4X), pause, (repeat)	Over Temperature Fault	Turn the dimmer down to 0% and allow fixture to cool. Check fan and vents.
Light intensity is decreased by 50%.	green solid on	Fan is OFF (Local or DMX control).	Change fan settings, if desired.
Light intensity is decreased by 50%.	red flash, pause, red flashes (3X), pause, (repeat)	Fan is malfunctioning.	Check the fan for stoppage or blockage. Replace fan module if fan is permanently disabled.
The light is not operating normally.	red flashes (other)	Fixture is malfunctioning.	Note the red flashes pattern and contact service at litepanels.com/support