

Canon

Zoom Lens

CN7x17

CN8x15

CN10x25

OPERATION MANUAL "Information display"

Read this operation manual before using the product.

Memo

ENGLISH

Memo

Introduction

Thank you for purchasing a Canon zoom lens.

This product comes with the following documents:

- Operation Manual "Before Using The Product" (Included with the product)
- Operation Manual "Regulations" (Included with the product)
- Operation Manual "Lens" (Web)
- Operation Manual "Information display" (Web)
- Quick guide "Information display" (Web)
- Depth-of-field (Web)

Refer to this Operation Manual "Information display" for operating instructions and procedures for the information display.

The copyright for this manual is retained by Canon Inc.
Unauthorized copying or reproduction in whole or part is prohibited.

Contents

Introduction E3

Manual Layout..... E7

Manual Conventions..... E8

Part Names E9

Part Names and Functions..... E9

Operation Key Names and Operation Methods E9

Basic Sequence of Operations E10

1. Screen Organization E11

1.1 Top Screen E12

1.2 Menu Screen E14

2. Mode Selection E17

2.1 Modes E18

3. Operation in Basic Mode E19

3.1 Configuration from the Top Screen E20

3.1.1 Selecting Basic Mode..... E21

3.1.2 Top Screen E22

3.1.3 Specifying Auto Iris Gain E24

3.1.4 Assigning Functions to the AUX Switch..... E25

3.1.5 Auto-Adjusting the Mechanical End..... E26

3.1.6 Assigning Functions to the AUX1 Switch..... E27

3.1.7 Zoom Tracking ON/OFF E28

3.1.8 Assigning Functions to the AUX2 Switch..... E29

3.1.9 Specifying Iris Torque E30

3.1.10 Specifying Zoom Curve Mode E31

3.2 Configuration from the Menu Screen	E33
3.2.1 User Screen Settings	E34
3.2.2 Switch Screen Settings	E40
3.2.3 Preset Screen Settings.....	E44
3.2.4 Iris Screen Settings	E48
3.2.5 Zoom Screen Settings.....	E55
3.2.6 Focus Screen Settings	E59
3.2.7 Info Screen Settings.....	E61
3.2.8 Fol. Screen Settings.....	E68
3.3 List of Settings.....	E70

4. Operation in Full Mode E73

4.1 Configuration from the Top Screen	E74
4.1.1 Selecting Full Mode.....	E75
4.1.2 Top Screen	E76
4.1.3 Switching Users.....	E78
4.1.4 Switching to Basic Mode	E79
4.1.5 Auto-Adjusting the Mechanical End.....	E80
4.1.6 Specifying Iris Gain	E81
4.1.7 Zoom Tracking ON/OFF	E83
4.1.8 Assigning Functions to the AUX Switch.....	E84
4.1.9 Specifying Iris Torque	E85
4.1.10 Assigning Functions to the AUX1 Switch.....	E86
4.1.11 Assigning Functions to the VTR Switch.....	E87
4.1.12 Assigning Functions to the AUX2 Switch.....	E88
4.1.13 Assigning Functions to the RET Switch.....	E89
4.1.14 Specifying Zoom Curve Mode	E90
4.1.15 Assigning Functions to the Seesaw.....	E92
4.1.16 Specifying Iris A/M Switch	E93
4.1.17 Escape Operation.....	E94
4.2 Configuration from the Menu Screen	E95
4.2.1 User Screen Settings	E96
4.2.2 Switch Screen Settings	E113
4.2.3 Preset Screen Settings.....	E121
4.2.4 Iris Screen Settings	E127
4.2.5 Zoom Screen Settings.....	E134

4.2.6 Focus Screen Settings	E145
4.2.7 Info Screen Settings	E147
4.2.8 Fol. Screen Settings	E154
4.3 List of Settings	E156

5. Operation in Analog Mode E159

5.1 Configuration from the Top Screen	E160
5.1.1 Selecting Analog Mode.....	E161
5.1.2 Top Screen	E162
5.1.3 Specifying Auto Iris Gain	E163
5.1.4 Switching to Basic Mode	E164
5.2 Configuration from the Menu Screen	E165
5.2.1 User Screen Settings	E166
5.3 List of Settings	E171

Manual Layout

Pages with instructions are organized as follows.

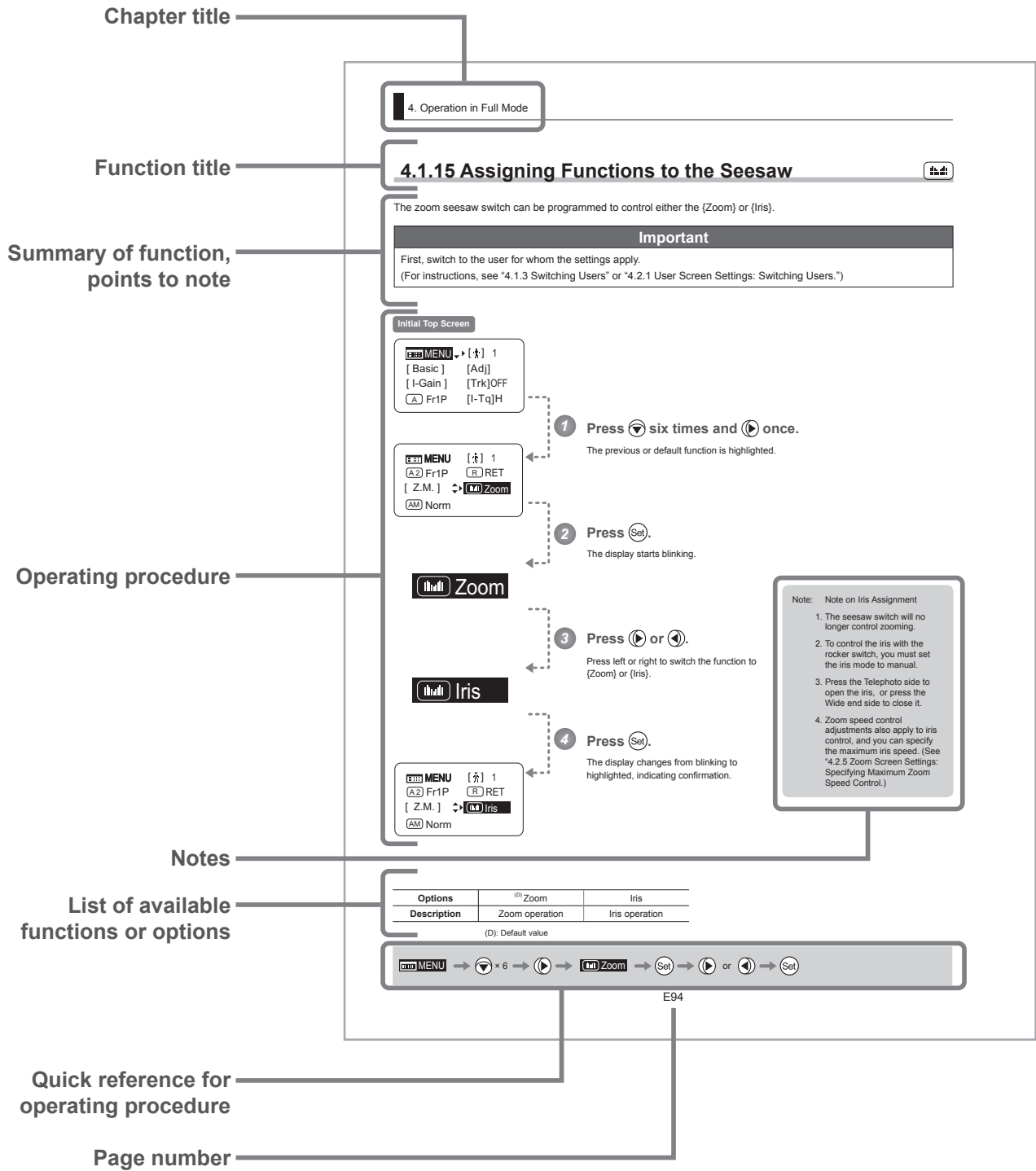

Manual Conventions

The following conventions are used in this manual.







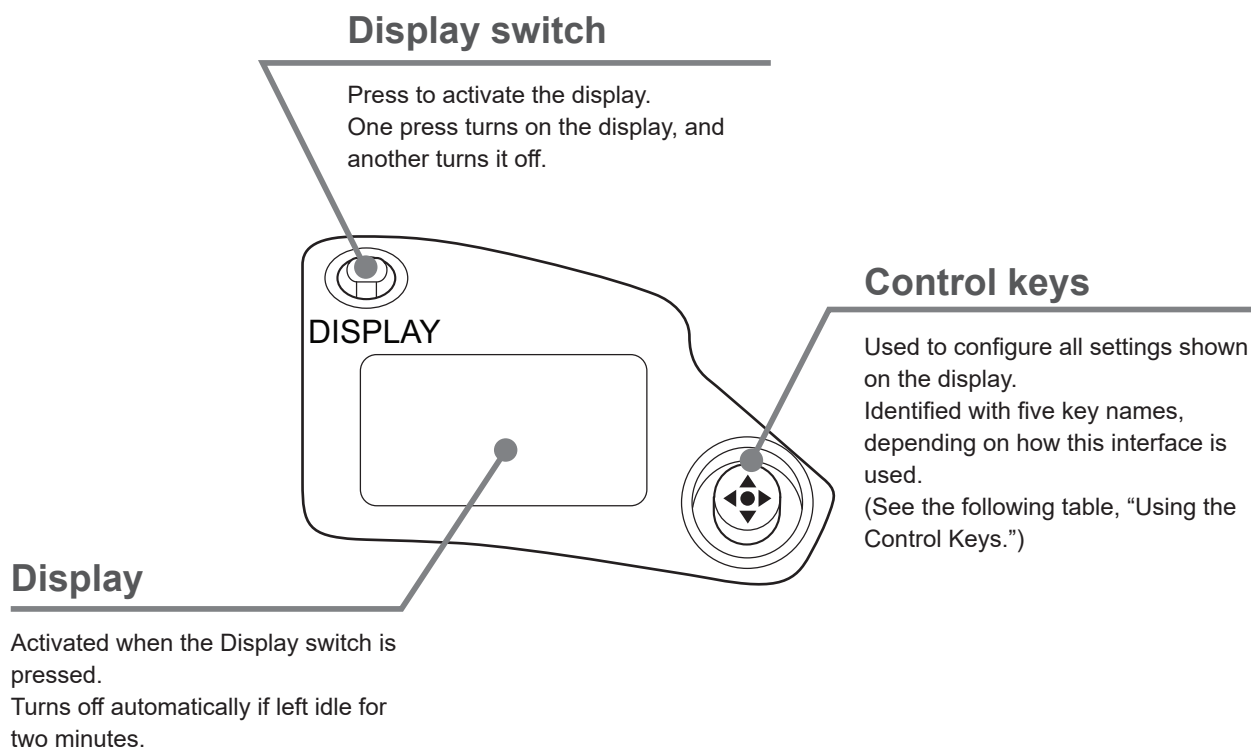







Convention	Description	Example
<u>** screen</u>	Names of screens are underlined.	The <u>Top screen</u> is displayed.
[]	Names of setting items are enclosed in square brackets.	[Frame 1] is underlined.
{ }	Names of options are enclosed in curly brackets.	Select {FAST}.

Part Names

Part Names and Functions



Operation Key Names and Operation Methods

Key	Operation	Details	Manual Convention
Set key	Press 	Pressed when {  } is displayed, or when entering a selection.	
Right key	Move right 	Can be used when {  } is displayed.	
Left key	Move left 	Can be used when {  } is displayed.	
Up key	Move up 	Can be used when {  } is displayed.	
Down key	Move down 	Can be used when {  } is displayed.	

Basic Sequence of Operations

1 Turn on the lens.

Note: For instructions on turning the lens on, refer to the camera manual.

2 Press the Display switch.

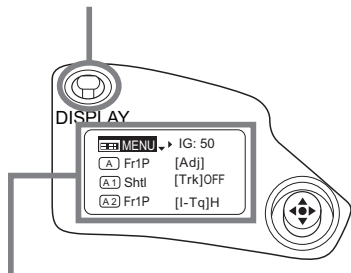

The display is now illuminated.

3 Use the control keys to complete settings.

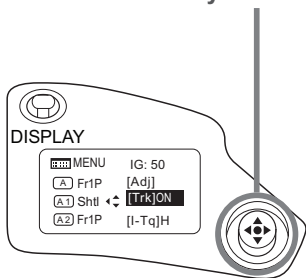

Changes are saved.

Note: The display turns off automatically after two minutes if no control keys are pressed. (Auto Off.) However, the display remains active as long as the Fol. screen is shown. In this case, it is only deactivated when you press the Display switch.

4 Press the Display switch.

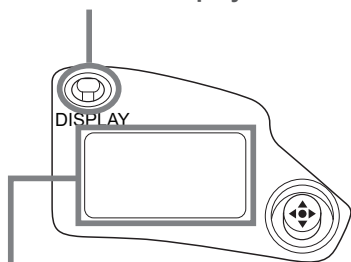

The display is turned off.

Note: Any changes to settings are saved even if the display is automatically deactivated, just as they are when it is switched off manually.

When the display is deactivated manually, changes to settings are saved and the display is turned off.

However, if the lens is turned off while the display is on, changes to settings may not be saved.

Important

For Reference: Display appearance when restoring original settings

Basic Mode

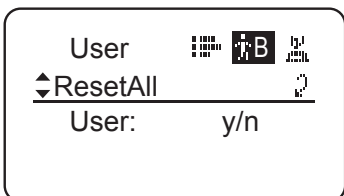

Full Mode

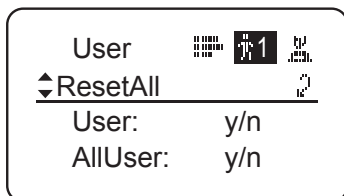

Restoring the Original Settings

The original settings can be restored, in the case of incorrect settings or if you have tried some settings tentatively. For details, see “Resetting Values” in “3. Operation in Basic Mode” or “4. Operation in Full Mode.”

1

Screen Organization

1. Screen Organization

Screens contain 22 setting items in Basic mode, 38 in Full mode, and 3 in Analog mode, with Basic and Full modes also including a “follow” screen containing three setting items that have relative values. To access frequently used items on the **Top screen**, press the Display switch. All settings can be configured from the **Menu screen**, which also includes advanced settings. (See “Menu Screen” in “1. Screen Organization.”)

1.1 Top Screen

(For instructions on configuring the settings, see “Configuration from the Top Screen” in each mode.)

The **Top screen** contains 9 setting items in Basic mode, 15 in Full mode, and 3 in Analog mode.

Initial Top Screen in Basic Mode

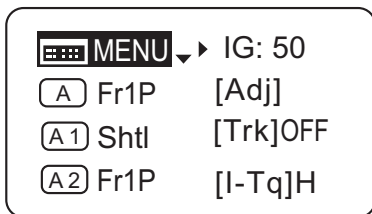

Top Screen in Basic Mode

Of the 9 setting items in Basic mode, the 8 more common are shown on the **Top screen**. The other 1 can be accessed by pressing down to scroll down the screen.

1. Go to Menu screen
2. Auto iris gain settings
3. AUX switch assignment
4. Mechanical end auto-adjustment
5. AUX1 switch assignment
6. Zoom tracking ON/OFF
7. AUX2 switch assignment
8. Iris torque settings
9. Zoom curve mode settings

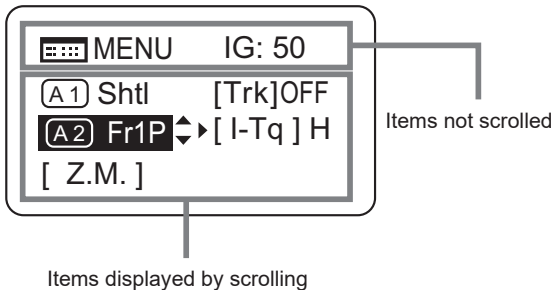

Initial Top Screen in Full Mode

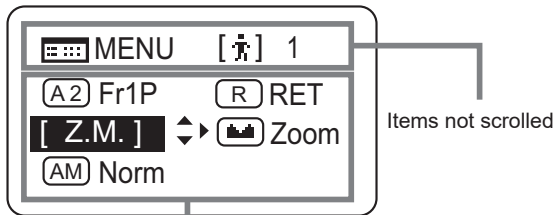
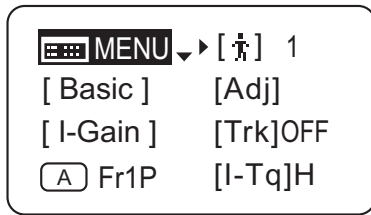

Items displayed by scrolling

Top Screen in Full Mode

Of the 15 setting items in Full mode, the 8 most common are shown on the **Top screen**. The other 6 can be accessed by pressing down to scroll down the screen.

1. Go to Menu screen
2. Switch users
3. Switch to Basic mode
4. Mechanical end auto-adjustment
5. Iris gain settings
6. Zoom tracking ON/OFF
7. AUX switch assignment
8. Iris torque settings
9. AUX1 switch assignment
10. VTR switch assignment
11. AUX2 switch assignment
12. RET switch assignment
13. Zoom curve mode settings
14. Seesaw switch assignment
15. Iris A/M switch setting

Initial Top Screen in Analog Mode

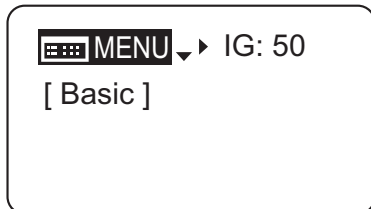

Top Screen in Analog Mode

1. Go to Menu screen
2. Auto iris gain settings
3. Switch to Basic mode

1.2 Menu Screen







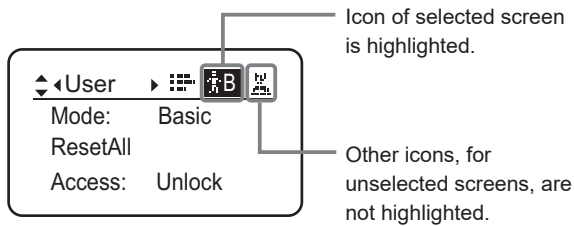

(For instructions on configuring the settings, see the “Menu Screen” section in the descriptions of each mode.)

Setting items in each mode and on the “follow” screen are organized by function. All of these screens are collectively referred to as the **Menu screen**.^{*1}

Menu Screen in Basic Mode

In Basic mode, the 22 setting items and three “follow” settings with relative values are organized by function into the following 8 screens.



1. User screen 
2. Switch screen 
3. Preset screen 
4. Iris screen 
5. Zoom screen 
6. Focus screen 
7. Info screen 
8. Fol. screen 

*1: There is no single **Menu screen**. Instead, these 8 screens are collectively referred to as the **Menu screen**.

To access these screens, select [MENU] on the **Top screen** and press the Set key. Initially, the **User screen** is displayed. To access other screens, press left or right.



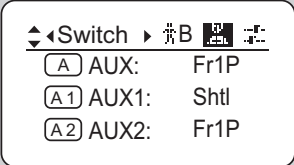
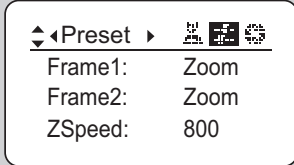
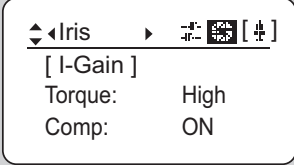
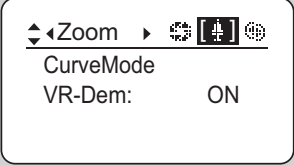
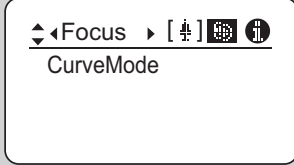
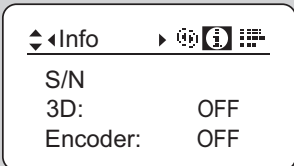
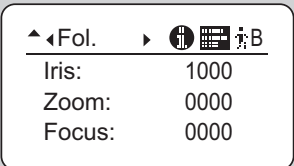



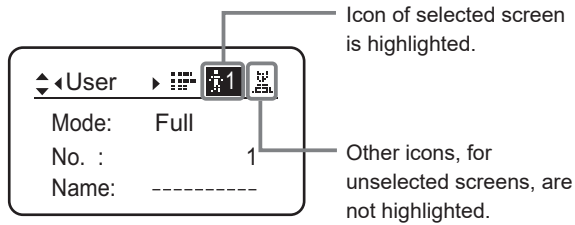

Menu Screen in Basic Mode

<p>User screen</p> 	<p>Switch screen</p> 	<p>Preset screen</p> 
<p>Iris screen</p> 	<p>Zoom screen</p> 	<p>Focus screen</p> 
<p>Info screen</p> 	<p>Fol. screen</p> 	

Menu Screen in Full Mode

In Full mode, the 38 setting items and three “follow” settings with relative values are organized by function into the following 8 screens.



1. User screen 
2. Switch screen 
3. Preset screen 
4. Iris screen 
5. Zoom screen 
6. Focus screen 
7. Info screen 
8. Fol. screen 

*1: There is no single **Menu screen**. Instead, these 8 screens are collectively referred to as the **Menu screen**.

To access these screens, select [MENU] on the **Top screen** and press the Set key. Initially, the **User screen** is displayed. To access other screens, press left or right.

Menu Screen in Full Mode

User screen

◀User ▶ 

Mode: Full

No. : 1

Name: -----

Switch screen

◀Switch ▶  1

(A) AUX: Fr1P

(A1) AUX1: Shtl

(A2) AUX2: Fr1P

Preset screen

◀Preset ▶ 

Frame1: Zoom

Frame2: Zoom

ZSpeed: 800

Iris screen

◀Iris ▶ 

[I-Gain]

Torque: High

Comp: ON

Zoom screen

◀Zoom ▶ 

Tracking: OFF

Movement

CurveMode

Focus screen

◀Focus ▶ 

CurveMode

Info screen

◀Info ▶ 

S/N

3D: OFF

Encoder: OFF

Fol. screen

◀Fol. ▶  1

Iris: 1000

Zoom: 0000

Focus: 0000

Menu Screen in Analog Mode

In Analog mode, 2 setting items are presented as the **User screen**.

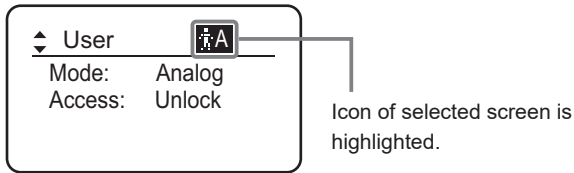

1. User screen 

*1: There is no single **Menu screen**. Instead, screens accessed by selecting [MENU] are collectively referred to as the **Menu screen**.

To access this screen, select [MENU] on the **Top screen** and press the Set key. The **User screen** is now displayed.

Menu Screen in Analog Mode



2

Mode Selection

2. Mode Selection

2.1 Modes

The following 3 modes are available. Choose a mode that suits your purpose or preference.

- 1. Basic Mode:** Restricted settings and information. Recommended for users who do not require sophisticated settings. This is the default mode.
- 2. Full Mode:** All settings and information are available.
- 3. Analog Mode:** Used when no digital functions are needed.

For details, see “3. Operation in Basic Mode,” “4. Operation in Full Mode,” or “5. Operation in Analog Mode.”

3

Operation in Basic Mode

3. Operation in Basic Mode

3.1 Configuration from the Top Screen

To access the **Top screen**, press the Display switch.

A total of 9 items can be configured on the **Top screen** in Basic mode. The first screen displayed is referred to as the **Initial Top screen**. Status of some items can be checked simply by accessing this screen.

Initial Top Screen in Basic Mode

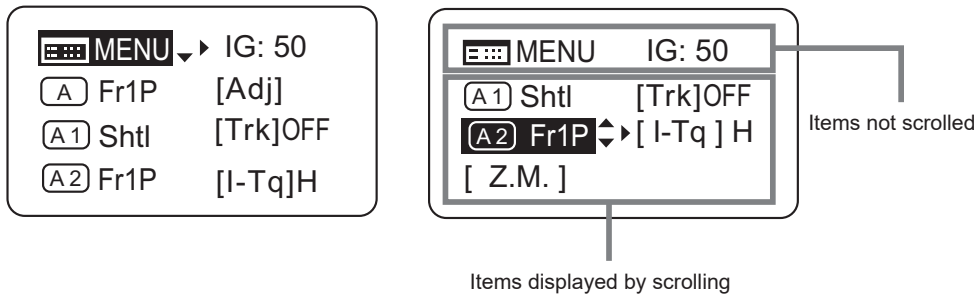

3.1.1 Selecting Basic Mode

Basic mode is the default mode, but it can also be accessed from other modes as follows.

Switching from Full to Basic Mode

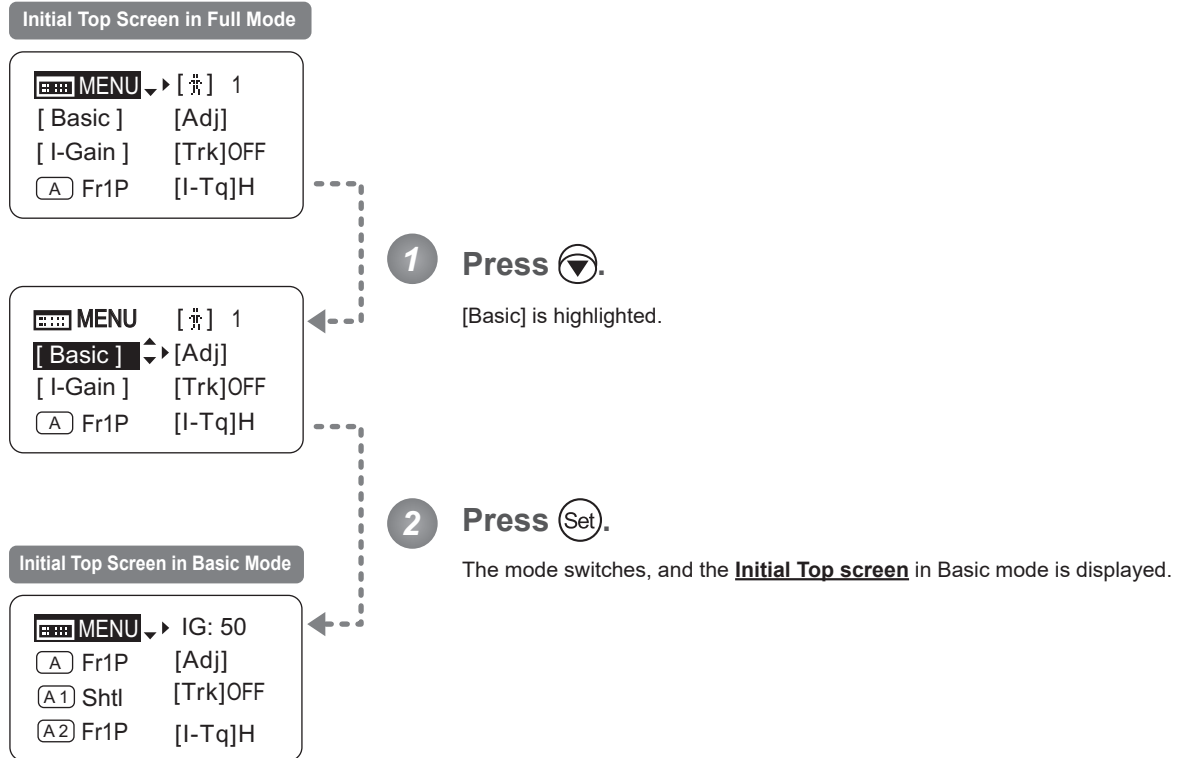

3.1.2 Top Screen

A total of 9 items can be configured on the **Top screen** in Basic mode, and 8 items are shown on the **Initial Top screen**. The other items can be accessed by pressing down to scroll down the screen. (See the following figure.) Status of some items can be checked simply by accessing this screen. (Shown in the figure below.^{*1)}

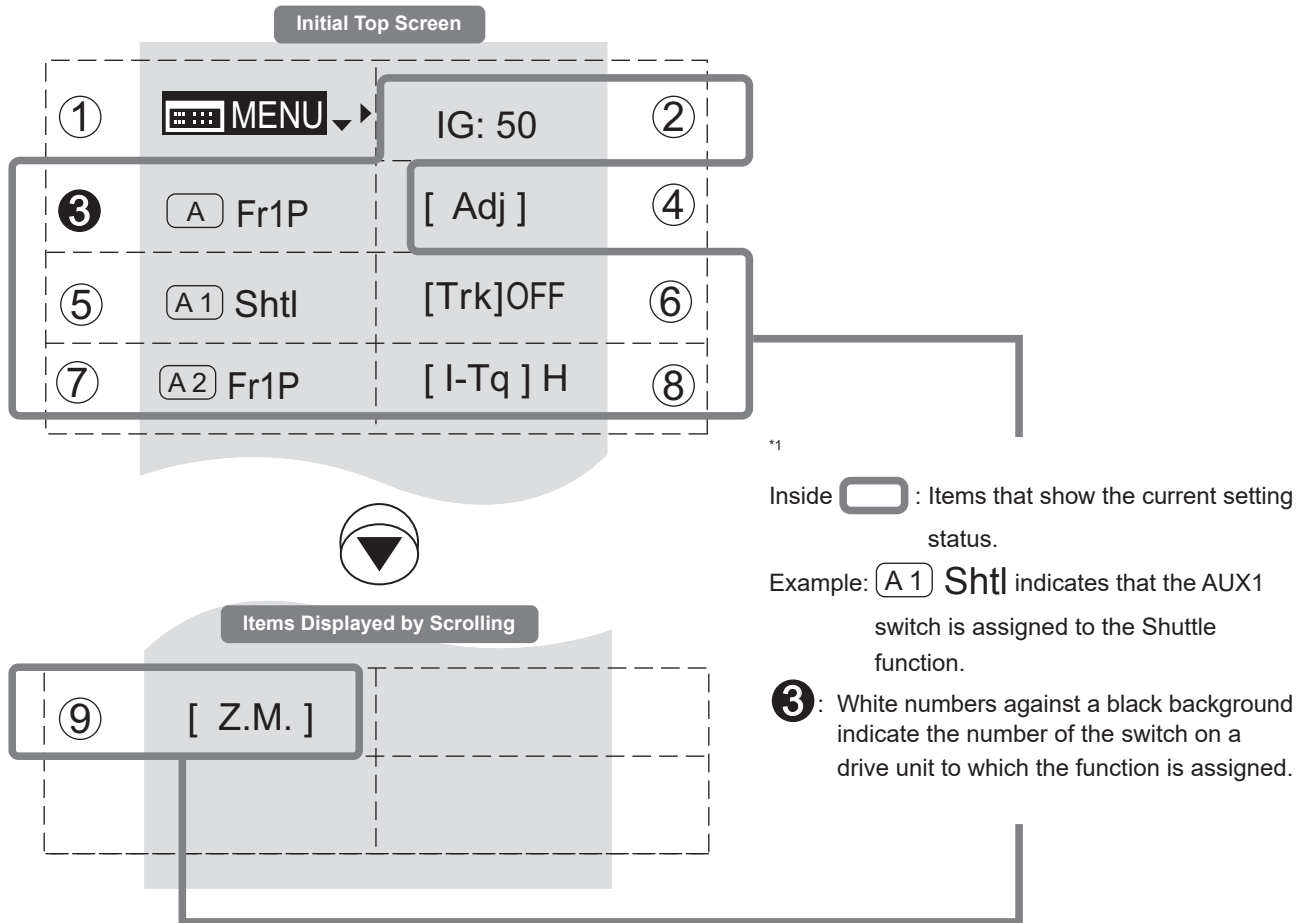

①  **Menu screen**

See “3.2 Configuration from the Menu Screen.”

② **IG Auto iris gain**

Adjust the auto iris gain value as needed.

See “3.1.3 Specifying Auto Iris Gain.”

③ **A AUX switch**

By default, the AUX switch for a drive unit is assigned to the {Frame Preset 1} function, but it can be reassigned as needed.

See “3.1.4 Assigning Functions to the AUX Switch.”

④ **[Adj] Mechanical end auto-adjustment**

Perform automatic adjustment of the mechanical end in zoom, focus, and iris operations on the lens and drive unit.

See “3.1.5 Auto-Adjusting the Mechanical End.”

⑤ **A1 AUX1 switch**

By default, the AUX1 switch for a zoom demand is assigned to the {Shuttle} function, but it can be reassigned as needed.

See “3.1.6 Assigning Functions to the AUX1 Switch.”

⑥ **[Trk] Zoom tracking**

Switch to ON when using zoom tracking.

See “3.1.7 Zoom Tracking ON/OFF.”

⑦ **A2 AUX2 switch**

By default, the AUX2 switch for a zoom demand is assigned to the {Frame Preset 1} function, but it can be reassigned as needed.

See “3.1.8 Assigning Functions to the AUX2 Switch.”

⑧ **[I-Tq] Iris torque**

Adjust the level of torque in manual control of the iris ring as needed.

See “3.1.9 Specifying Iris Torque.”

⑨ **[Z.M.] Zoom curve mode**

Adjust zoom speed in response to pressing the zoom seesaw switch or tilting the analog demand thumb ring.

See “3.1.10 Specifying Zoom Curve Mode.”

3.1.3 Specifying Auto Iris Gain

[IG]

Although this value is factory-set, it can be adjusted as needed.

To adjust the value, use either the auto iris gain adjustment trimmer (refer to the operation manual "Lens") or display operations. Regardless of the method of adjustment used, the most recent setting takes precedence.

The same auto iris gain value applies to all users.

Initial Top Screen

MENU ▾ IG: 50

[A] Fr1P [Adj]

[A1] Shtl [Trk]OFF

[A2] Fr1P [I-Tq]H

Screen A

MENU ▾ **IG: 50**

[A] Fr1P [Adj]

[A1] Shtl [Trk]OFF

[A2] Fr1P [I-Tq]H

IG: 50

IG: 51

MENU ▾ **IG: 51**

[A] Fr1P [Adj]

[A1] Shtl [Trk]OFF

[A2] Fr1P [I-Tq]H

- 1 Press** .

Your selection is now highlighted.
- 2 Press** .

The display starts blinking.
- 3 Press** or .

Press left or right until you reach the desired value.
- 4 Press** .

The display changes from blinking to highlighted, indicating confirmation.

Note: Do the following when adjusting gain while checking iris operation.

- Confirm that the drive unit A/M switch is set to [Auto] mode.
- Set the camera iris mode to [Auto].

Note: As you look at the lens iris ring, set it to the position of maximum gain at which "focus hunting" does not occur.

Note: The current iris gain value is retained even if you reset other settings as described in "3.2.1 Resetting Values." For this reason, you will no longer be able to view the default setting. If necessary, make a note of the default setting before adjusting this value.

Options	01	to	99
Description	Minimum gain		Maximum gain

Default: Varies depending on the factory-set value, but corresponds to the value determined with the iris gain adjustment trimmer.



3.1.4 Assigning Functions to the AUX Switch

A

Assign your desired functions to the AUX switch.

Initial Top Screen

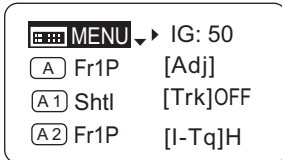

1 Press

The default function is highlighted.

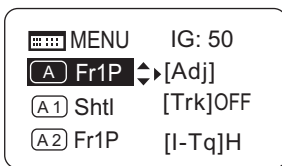

2 Press

The display starts blinking.



3 Press or .

Press left or right until you reach the desired function.



4 Press .

The display changes from blinking to highlighted, indicating confirmation.

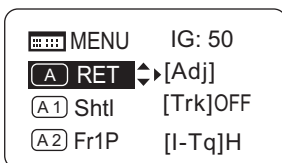

Options	^(D) Fr1P	Fr1F	Fr2P	Fr2F	Sped	Shtl	NON	VTR	RET
Description	Framing Preset1 switch (preset speed)	Framing Preset1 switch (max. speed)	Framing Preset2 switch (preset speed)	Framing Preset2 switch (max. speed)	Speed Preset switch	Shuttle-Shot switch	No function	VTR switch	RET switch

(D): Default value



3.1.5 Auto-Adjusting the Mechanical End

[Adj]

Perform automatic adjustment of the mechanical end in zoom, focus, and iris operations on the lens and drive unit.

Note

If “Auto-Adjustment: Error/Lens Interface: Non-Connected” is displayed after adjustment, contact Canon or your dealer.

Initial Top Screen

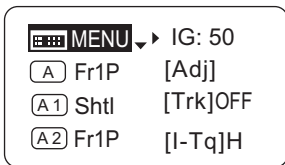

Screen A

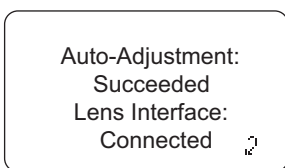
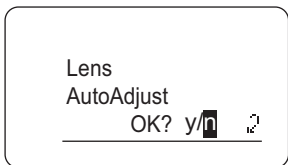
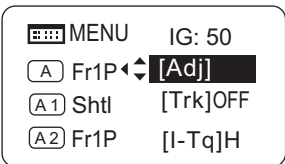

1 Press and then .

Your selection is now highlighted.

2 Press .

The display switches to the **Auto-Adjustment screen**.

3 Press and then .

Adjustment now begins.

During adjustment, the screen blinks.

After this, adjustment is finished.

Press after adjustment to return to **Screen A**.

Note: In manual zoom or focus modes, “Please Check Servo/ Manual OK?” is displayed after step 3. After checking, press to start adjustment.



3.1.6 Assigning Functions to the AUX1 Switch

A1

Assign your desired functions to the AUX1 switch.

Initial Top Screen

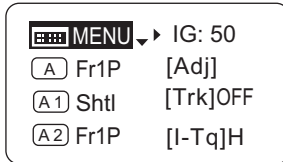

1 Press twice.

The default function is highlighted.

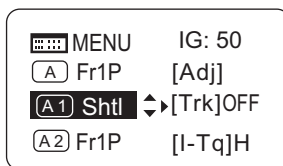

2 Press .

The display starts blinking.



3 Press or .

Press left or right until you reach the desired function.



4 Press .

The display changes from blinking to highlighted, indicating confirmation.

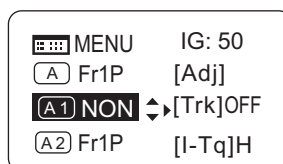

Options	Fr1P	Fr1F	Fr2P	Fr2F	Sped	^(D) Shtl	NON	VTR	RET
Description	Framing Preset1 switch (preset speed)	Framing Preset1 switch (max. speed)	Framing Preset2 switch (preset speed)	Framing Preset2 switch (max. speed)	Speed Preset switch	Shuttle-Shot switch	No function	VTR switch	RET switch

(D): Default value



3.1.7 Zoom Tracking ON/OFF

[Trk]

Activate or deactivate zoom tracking as needed.

Important

In Basic mode, any adjustments to this setting are not retained when the lens is turned off, and the default value is restored on startup.

Initial Top Screen

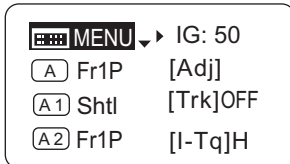

1 Press twice and once.

The default setting is highlighted.

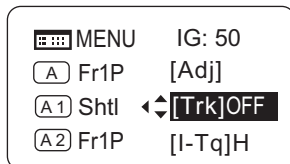

2 Press .

The display starts blinking.

[Trk]OFF

3 Press or .

Press left or right to switch the function {ON} or {OFF}.

[Trk]ON

4 Press .

The display changes from blinking to highlighted, indicating confirmation.

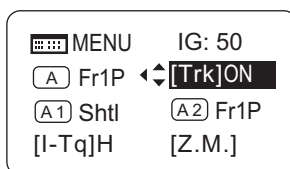

Options	^(D) OFF	ON
---------	--------------------	----

(D): Default value



3.1.8 Assigning Functions to the AUX2 Switch

A2

Assign your desired functions to the AUX2 switch.

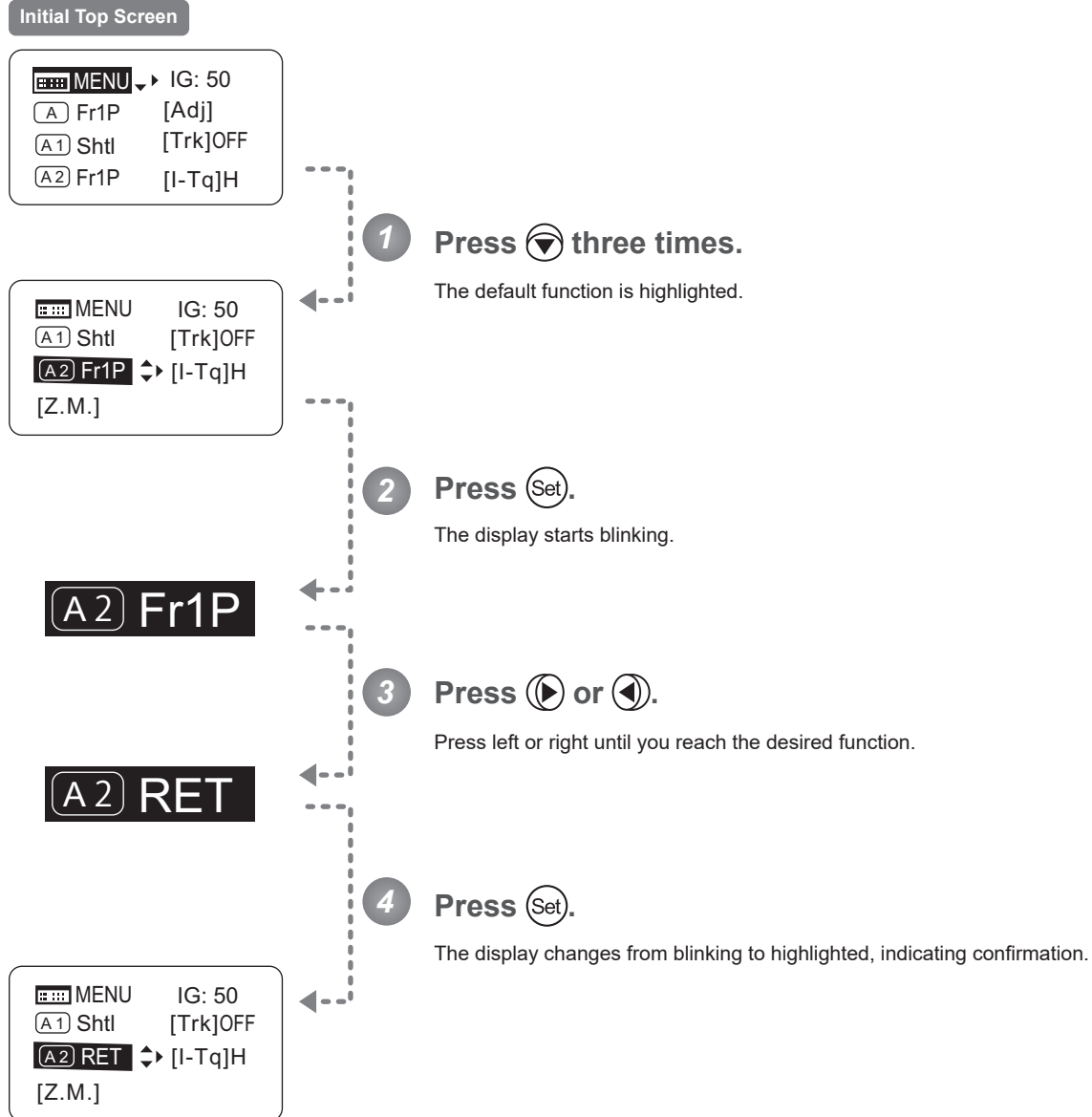

Options	^(D) Fr1P	Fr1F	Fr2P	Fr2F	Sped	Shtl	NON	VTR	RET
Description	Framing Preset1 switch (preset speed)	Framing Preset1 switch (max. speed)	Framing Preset2 switch (preset speed)	Framing Preset2 switch (max. speed)	Speed Preset switch	Shuttle-Shot switch	No function	VTR switch	RET switch

(D): Default value



3.1.9 Specifying Iris Torque

[I-Tq]

Specify the desired level of torque in manual control of the iris ring.

Initial Top Screen

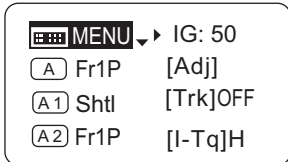

1 Press three times and once.

The default function is highlighted.

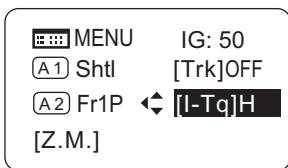

2 Press .

The display starts blinking.



3 Press or .

Press left or right to switch the function to {H} or {L}.



4 Press .

The display changes from blinking to highlighted, indicating confirmation.

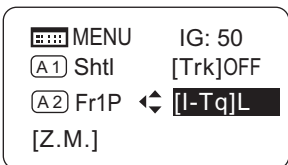

Options	^(D) H	L
Description	High torque	Low torque

(D): Default value



3.1.10 Specifying Zoom Curve Mode

[Z.M.]

Specifying Seesaw Switch Responsiveness

Configure the responsiveness of zoom speed adjustment in response to pressing the zoom seesaw switch.
 (Note: Another screen is displayed when this setting is configured.)

Initial Top Screen

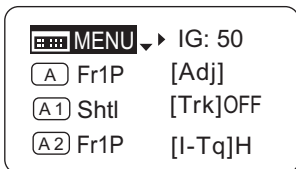

Screen A

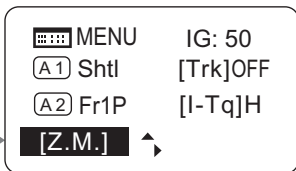

CurveMode Screen

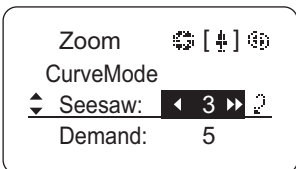
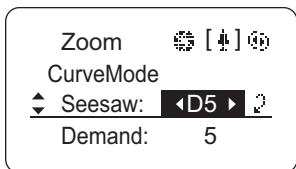
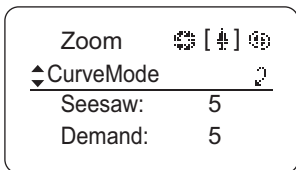

1 Press **four times.**

Your selection is now highlighted.

2 Press .

The display switches to the **CurveMode screen**.

3 Press .

[Seesaw] is underlined.
The default value is highlighted.

4 Press or .

Press left or right until you reach the desired value.

5 Press .

The display reverts to **Screen A**.

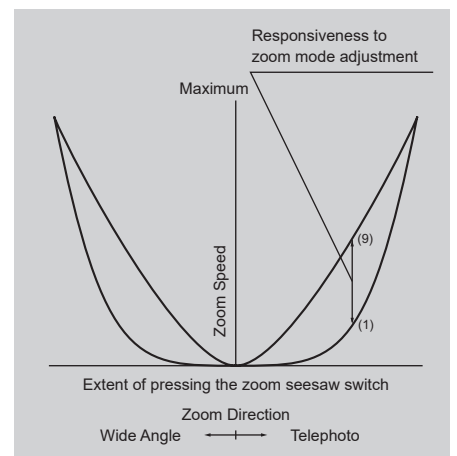

Options	1	2	3	4	(D) 5	6	7	8	9
---------	---	---	---	---	-------	---	---	---	---

(D): Default value



Specifying Analog Demand Responsiveness

Configure the responsiveness of zoom speed adjustment in response to pressing the analog demand thumb ring.
 (Note: Another screen is displayed when this setting is configured.)

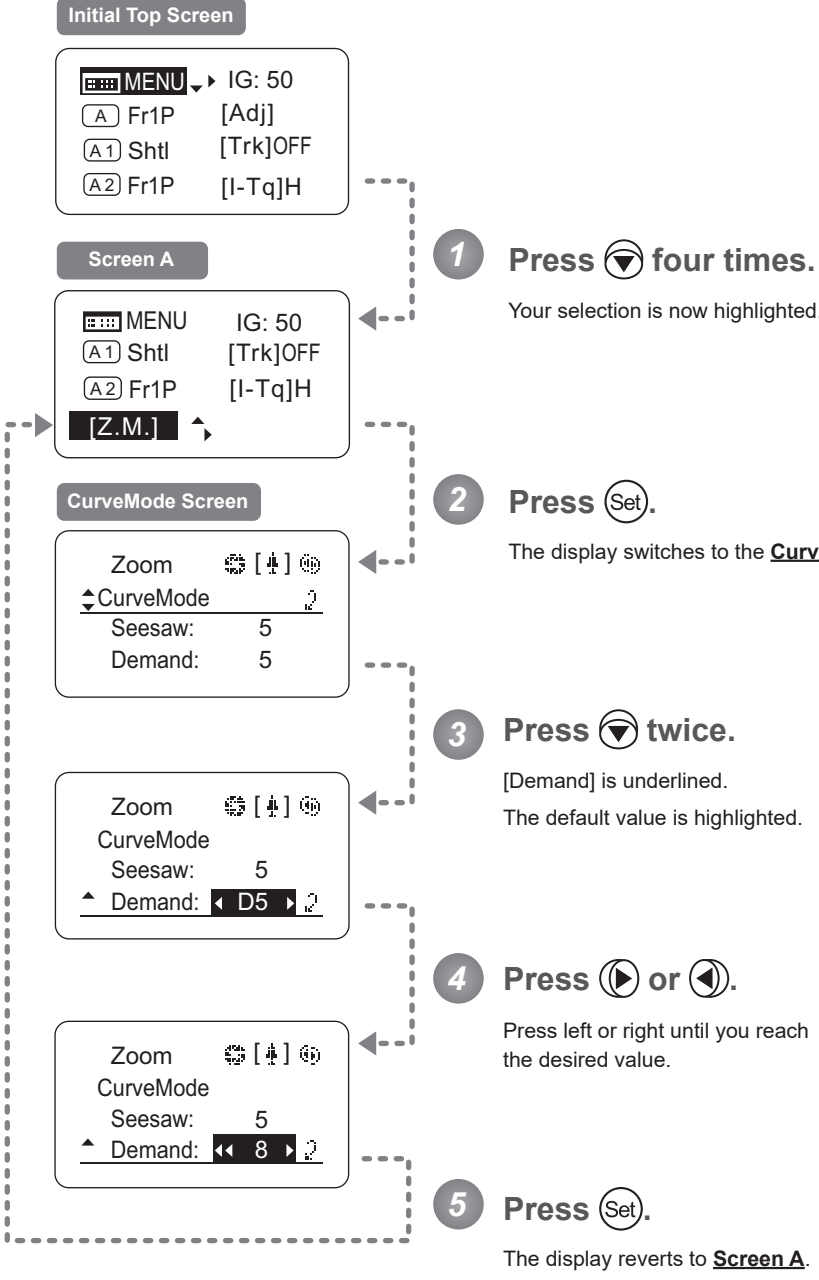

1 Press **four times.**
 Your selection is now highlighted.

2 Press **.**
 The display switches to the **CurveMode screen**.

3 Press **twice.**
 [Demand] is underlined.
 The default value is highlighted.

4 Press **or** **.**
 Press left or right until you reach the desired value.

5 Press **.**
 The display reverts to **Screen A**.

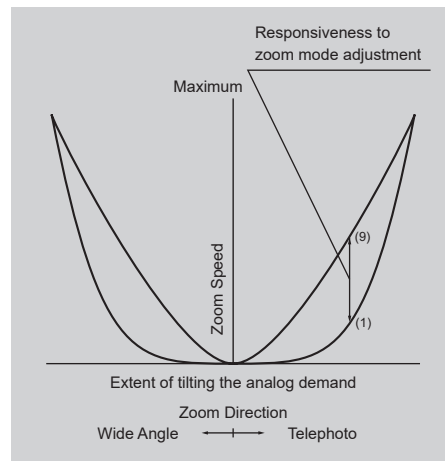

Options	1	2	3	4	(D) 5	6	7	8	9
---------	---	---	---	---	-------	---	---	---	---

(D): Default value



3.2 Configuration from the Menu Screen

In Basic mode, you can view and configure 22 setting items and a “follow” screen with three setting items that have relative values from the **Menu screen**.*

Specifically, the **Menu screen** in Basic mode is organized into 8 screens by function: **User screen**, **Switch screen**, **Preset screen**, **Iris screen**, **Zoom screen**, **Focus screen**, **Info screen**, and **Fol. screen**.

Select [MENU] on the **Top screen** and press the Set key to access the **User screen** initially. Press left or right to access the 7 other screens. (See the following figure.)

*: There is no single **Menu screen**. Instead, these 8 screens are collectively referred to as the **Menu screen**.

Setting items labeled **Top** next to the function title can also be configured from the **Top screen**.

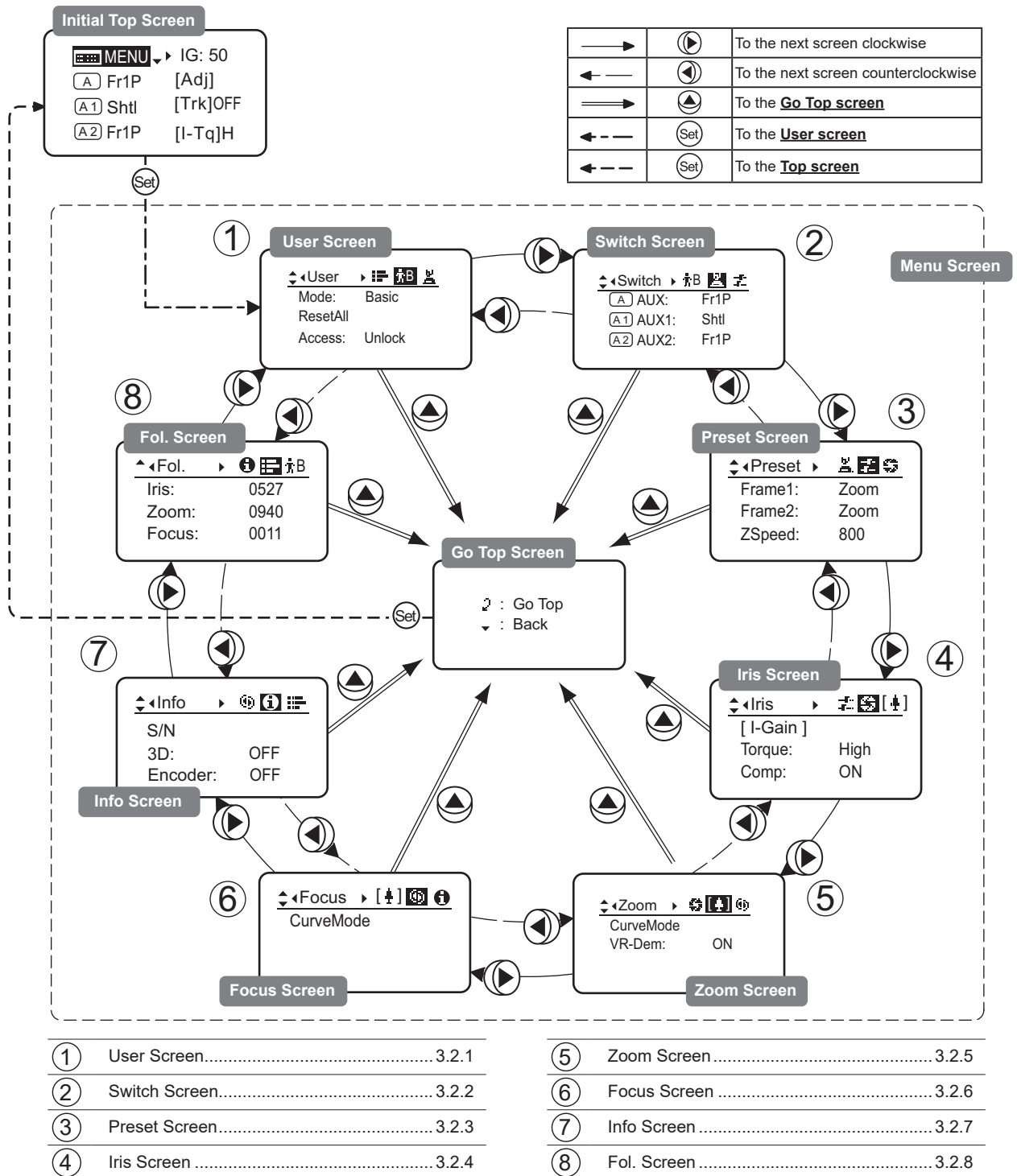

3.2.1 User Screen Settings

User B is the user in Basic mode.

The following setting items can be configured on the User Screen.

- Switching Modes
- Resetting Values
- Locking Functions

User Screen in Basic Mode

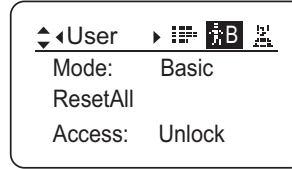

Switching Modes

Switch to Full or Analog mode as needed.

Important

The new mode setting is retained even after the lens is turned off.

Initial Top Screen

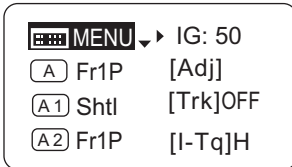

User Screen

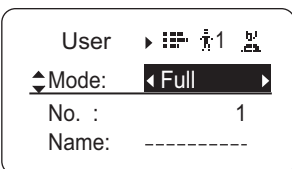
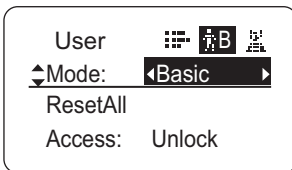
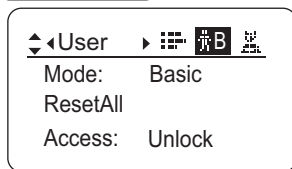

1 Press **Set**.

The display switches to the **User screen**.

2 Press **Down Arrow**.

[Mode] is underlined.
The previous mode is highlighted.

3 Press **Right Arrow** or **Left Arrow**.

Press left or right until you reach the desired mode.

Options	^(D) Basic	Full	Analog
Save Settings	Basic Mode	Full Mode	Analog Mode

(D): Default value



Resetting Values

Reset a user's settings to default values as needed.

Note: Iris gain values are not reset. The current value is retained.

Initial Top Screen

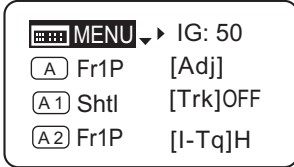

User Screen

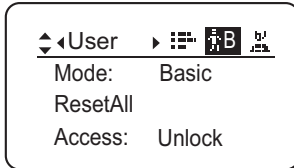

Title: Reset

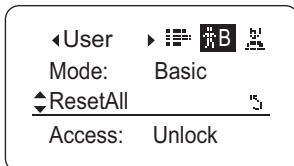

Reset Screen

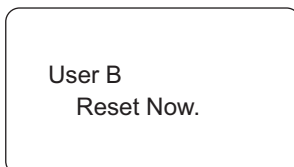
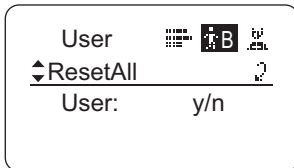

Title: Reset

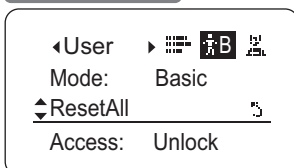

1 Press .
The display switches to the **User screen**.

2 Press twice.
[ResetAll] is underlined.

3 Press .
The display switches to the **Reset screen**.

4 Press .
A confirmation message is displayed about resetting information for the selected user.

5 Press and then .

After a message is displayed indicating that resetting is in progress, the display reverts to **Title: Reset**. The settings have now been reset.

Note: You can cancel resetting and restore the original values at any time before pressing in step 5. To return to the previous screen, press up. To cancel resetting and turn off the display, press the Display switch.



Locking Functions

To ensure that configured functions cannot easily be changed, you can lock the settings of certain functions.



Note

In lock mode, only the following items can still be configured, and other settings are locked.

- Preset data (Shuttle shot position, Frame preset position, Preset speed)
- Auto iris gain setting

(1) Locking Settings

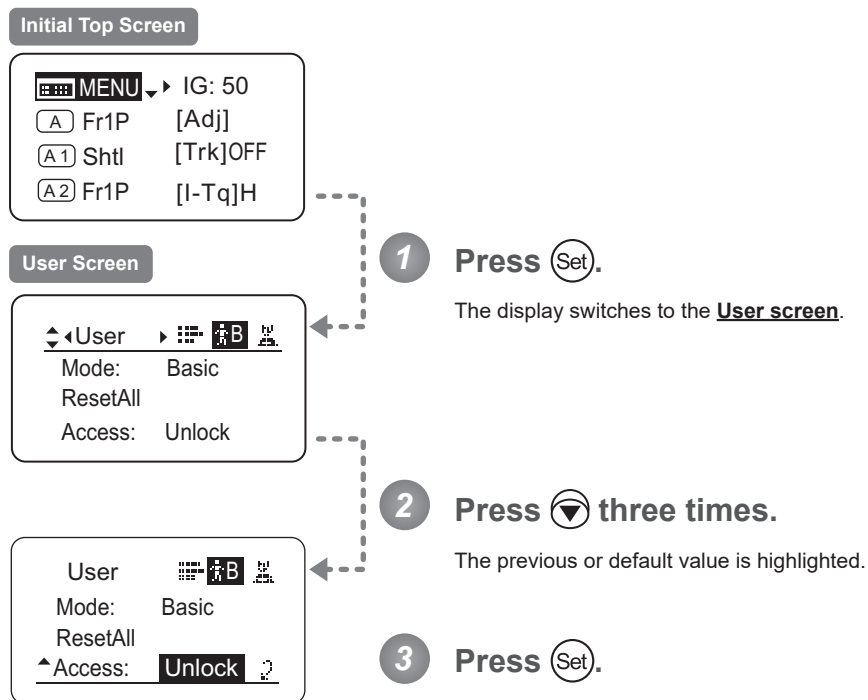

Continued on next page

Continued from previous page

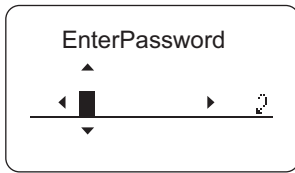

4 Enter the password and press (Set).

Entering Passwords

Press up/down to find characters and left/right to move the cursor or make corrections. Be careful not to press the Set key until you are finished entering the password.

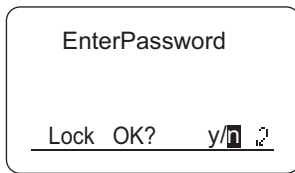

5 Press (Left Arrow) and then (Set).

The settings are now locked.

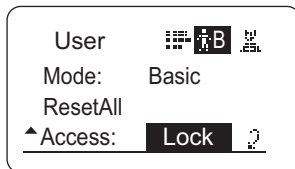

Note

Passwords

No master password is used on this model. The password you enter each time to lock settings is the password used to unlock them. For this reason, we recommend making a note of the password each time. If you forget the password, contact Canon or your dealer. Passwords can be blank or up to 8 digits.

Characters supported in passwords

Options	^(D) _-ABCDEFGHIJKLMN OPQRSTUVWXYZ abcdefghijklmnopqrstuvwxyz0123456789
Max. Digits	8

(D) : Default value
_ : Space

Options	^(D) Unlock	Lock
----------------	-----------------------	------

(D): Default value

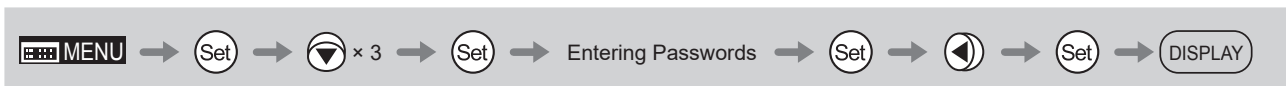

(2) Unlocking Settings

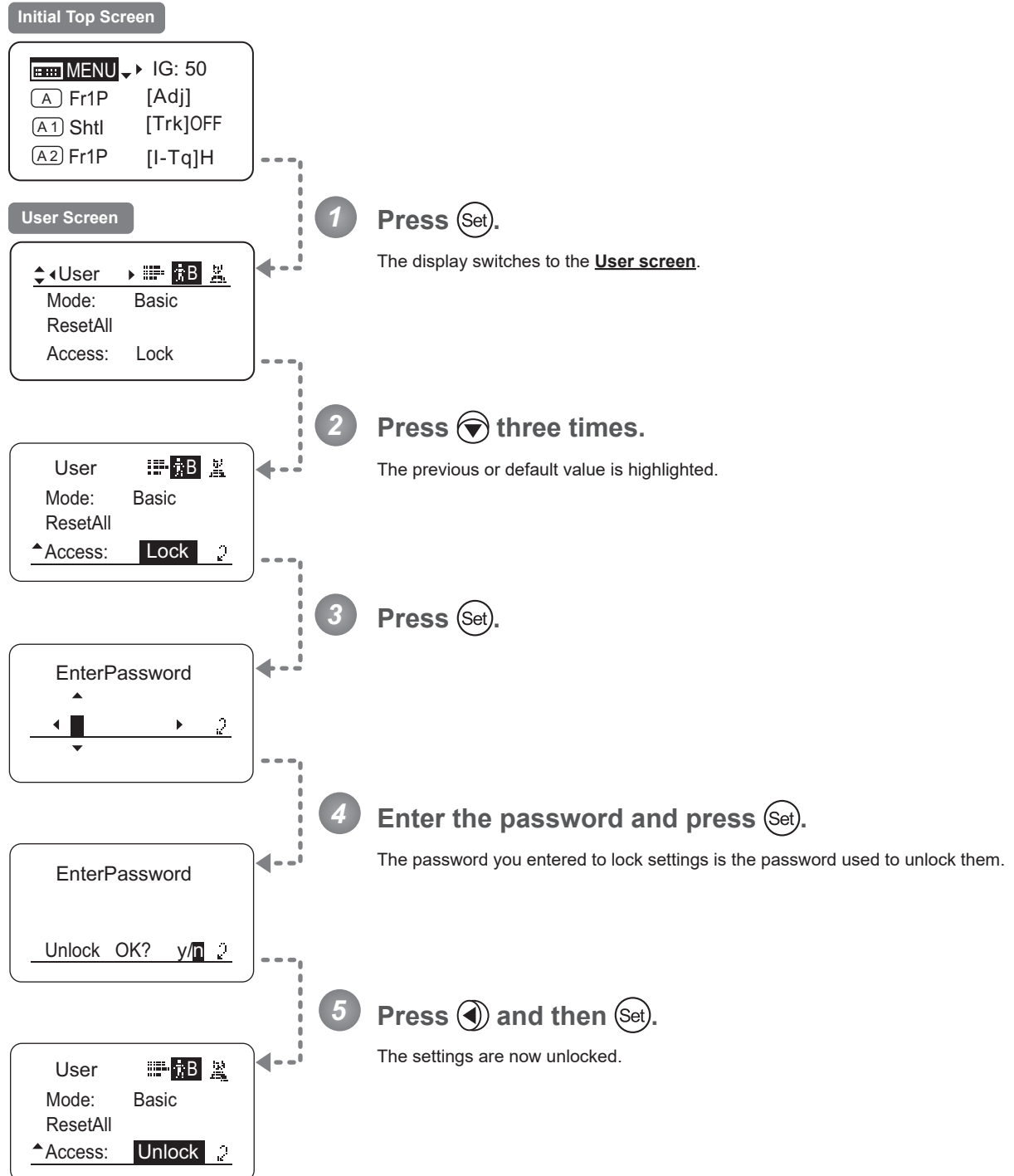

Options	^(D) Unlock	Lock
---------	-----------------------	------

(D): Default value

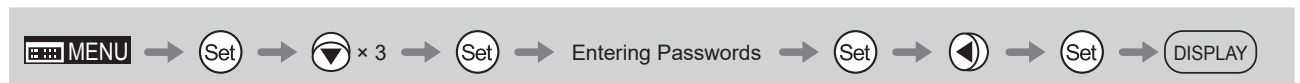

3.2.2 Switch Screen Settings

The following setting items can be configured on the Switch screen.

Assigning Functions to the AUX Switch **Top**

Assigning Functions to the AUX1 Switch **Top**

Assigning Functions to the AUX2 Switch **Top**

Items labeled **Top** can also be modified from the Top screen.

Assigning Functions to the AUX Switch Top

The AUX switch can be programmed to activate a function of your choice.

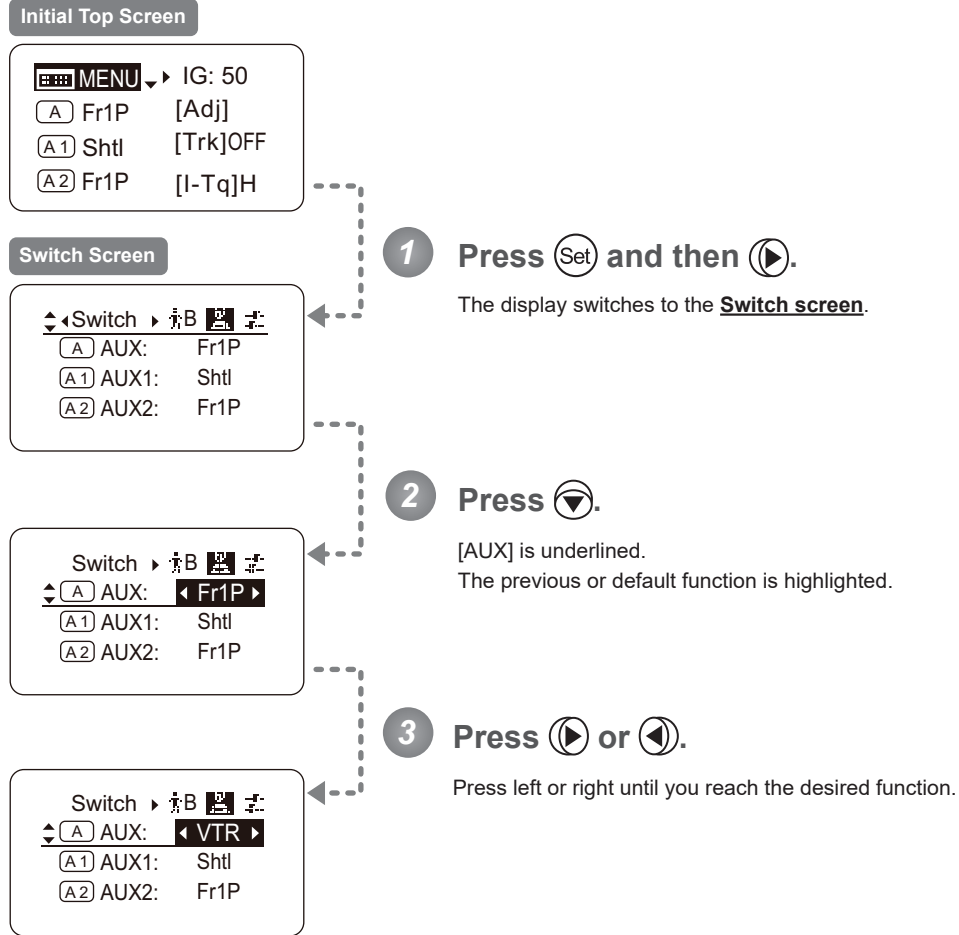

Options	^(D) Fr1P	Fr1F	Fr2P	Fr2F	Sped	Shtl	NON	VTR	RET
Description	Framing Preset1 switch (preset speed)	Framing Preset1 switch (max. speed)	Framing Preset2 switch (preset speed)	Framing Preset2 switch (max. speed)	Speed Preset switch	Shuttle-Shot switch	No function	VTR switch	RET switch

(D): Default value



Assigning Functions to the AUX1 Switch Top

The AUX1 switch for a zoom demand can be programmed to activate a function of your choice.

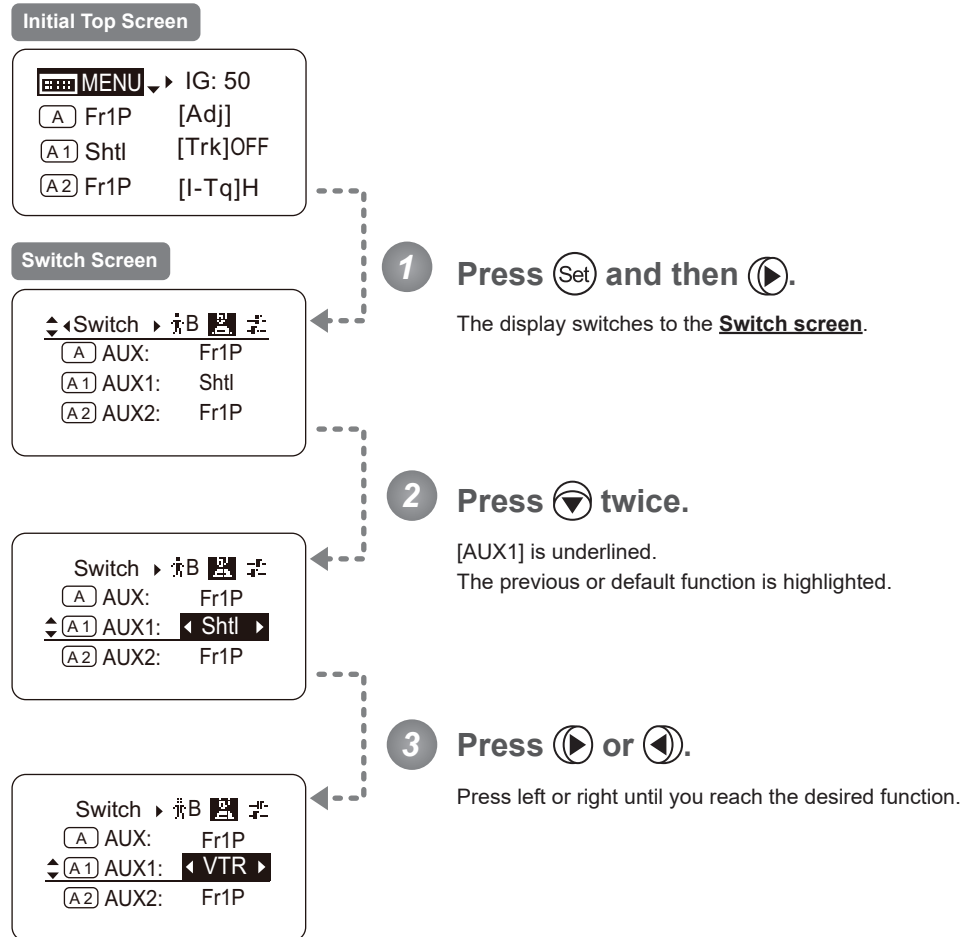

Options	Fr1P	Fr1F	Fr2P	Fr2F	Sped	^(D) Shtl	NON	VTR	RET
Description	Framing Preset1 switch (preset speed)	Framing Preset1 switch (max. speed)	Framing Preset2 switch (preset speed)	Framing Preset2 switch (max. speed)	Speed Preset switch	Shuttle-Shot switch	No function	VTR switch	RET switch

(D): Default value



Assigning Functions to the AUX2 Switch Top

The AUX2 switch for a zoom demand can be programmed to activate a function of your choice.

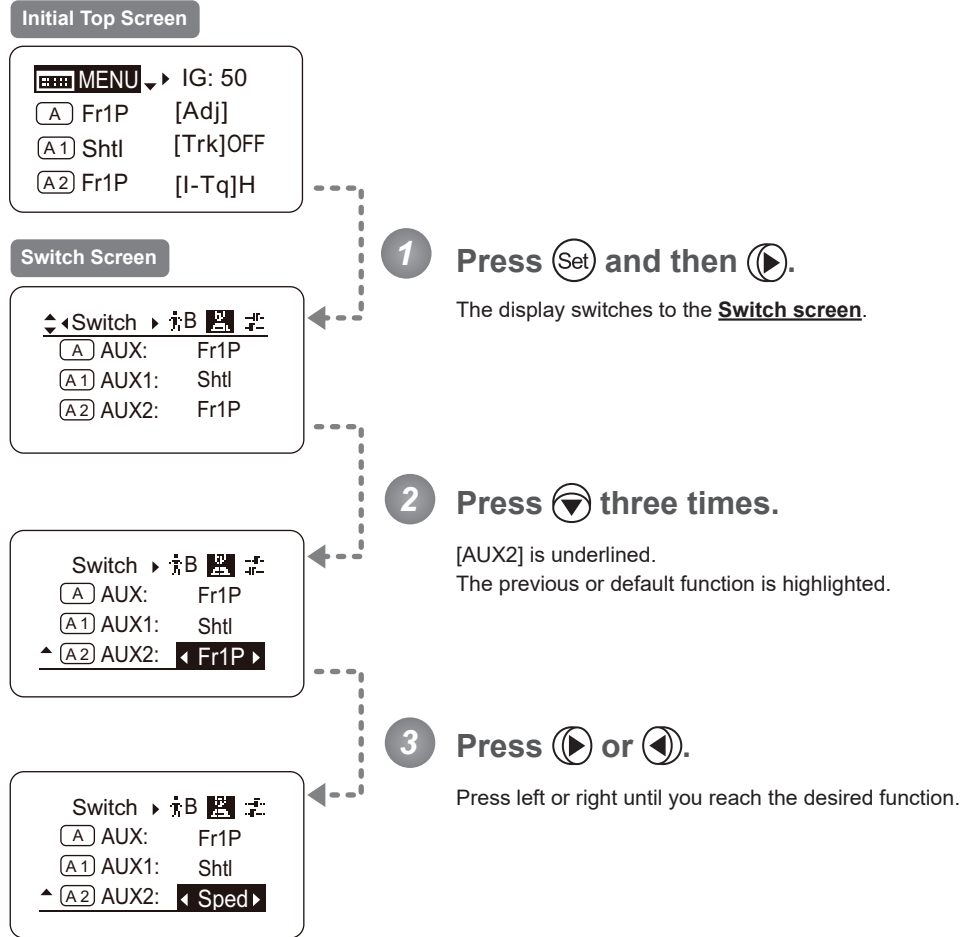

Options	^(D) Fr1P	Fr1F	Fr2P	Fr2F	Sped	Shtl	NON	VTR	RET
Description	Framing Preset1 switch (preset speed)	Framing Preset1 switch (max. speed)	Framing Preset2 switch (preset speed)	Framing Preset2 switch (max. speed)	Speed Preset switch	Shuttle-Shot switch	No function	VTR switch	RET switch

(D): Default value



3.2.3 Preset Screen Settings

The following setting items can be configured on the **Preset screen**.

Switching What Frame Preset 1 Controls

Switching What Frame Preset 2 Controls

Specifying the Preset Mode Zoom Speed

Switching What Frame Preset 1 Controls

Switch what frame preset 1 controls, as needed.

- Zoom : Move the zoom position to the position in memory
- Focus : Move the focus position to the position in memory
- Z+F : Move the zoom and focus position to the position in memory

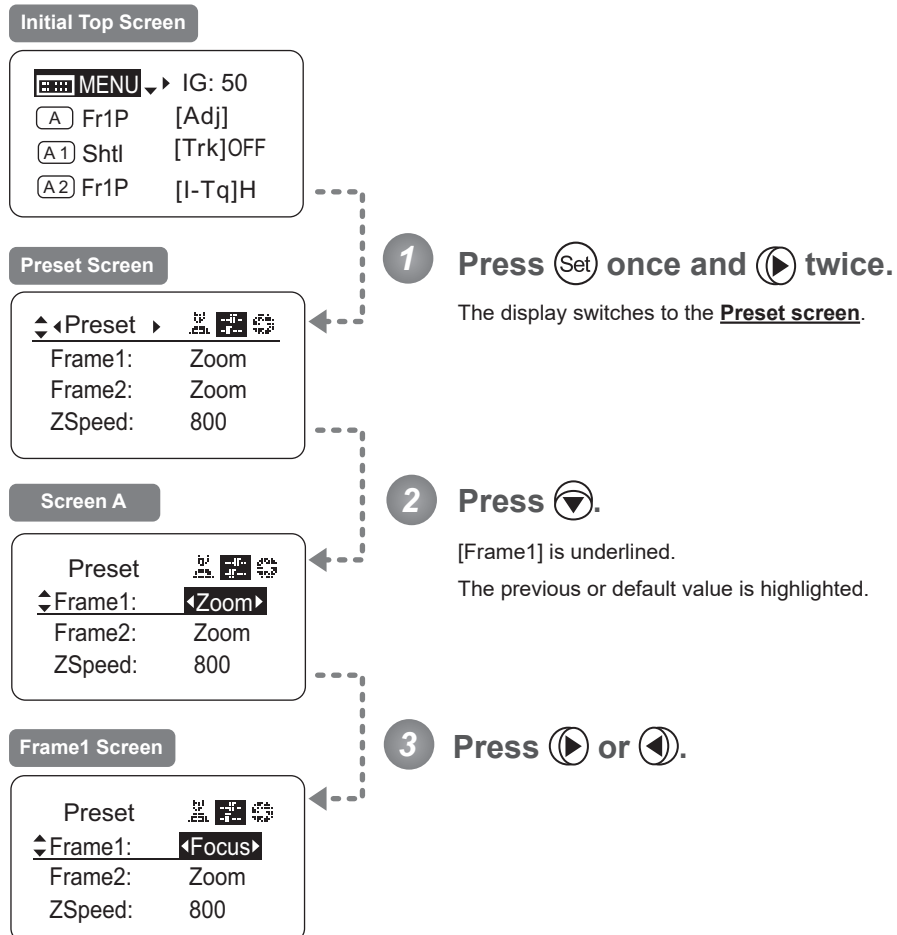

Options	^(D) Zoom	Focus	Z+F
Description	Control zooming	Control focusing	Control zooming and focusing

(D): Default value



Switching What Frame Preset 2 Controls

Switch what frame preset 2 controls, as needed.

- Zoom : Move the zoom position to the position in memory
- Focus : Move the focus position to the position in memory
- Z+F : Move the zoom and focus position to the position in memory

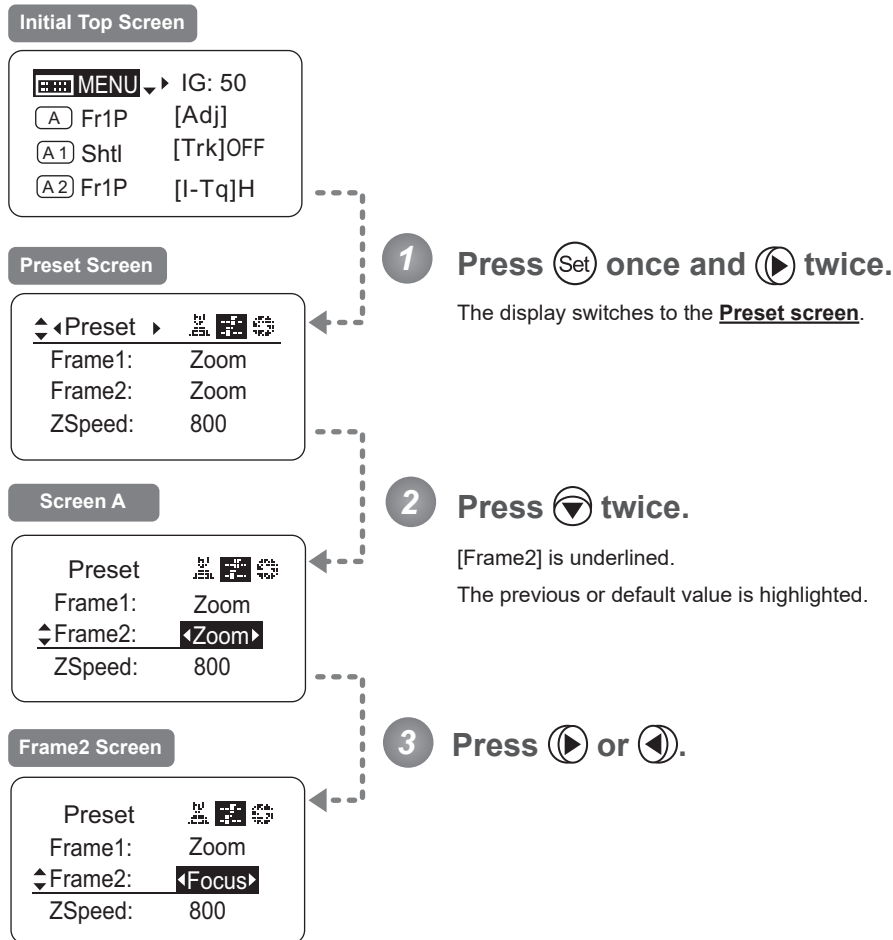

Options	^(D) Zoom	Focus	Z+F
Description	Control zooming	Control focusing	Control zooming and focusing

(D): Default value



Specifying the Preset Mode Zoom Speed

Configure the zoom speed from any position to the position in memory, as needed.

To adjust the value, use either the Memo button (refer to the operation manual "Lens") or display operations.

Regardless of the method of adjustment used, the most recent setting takes precedence.

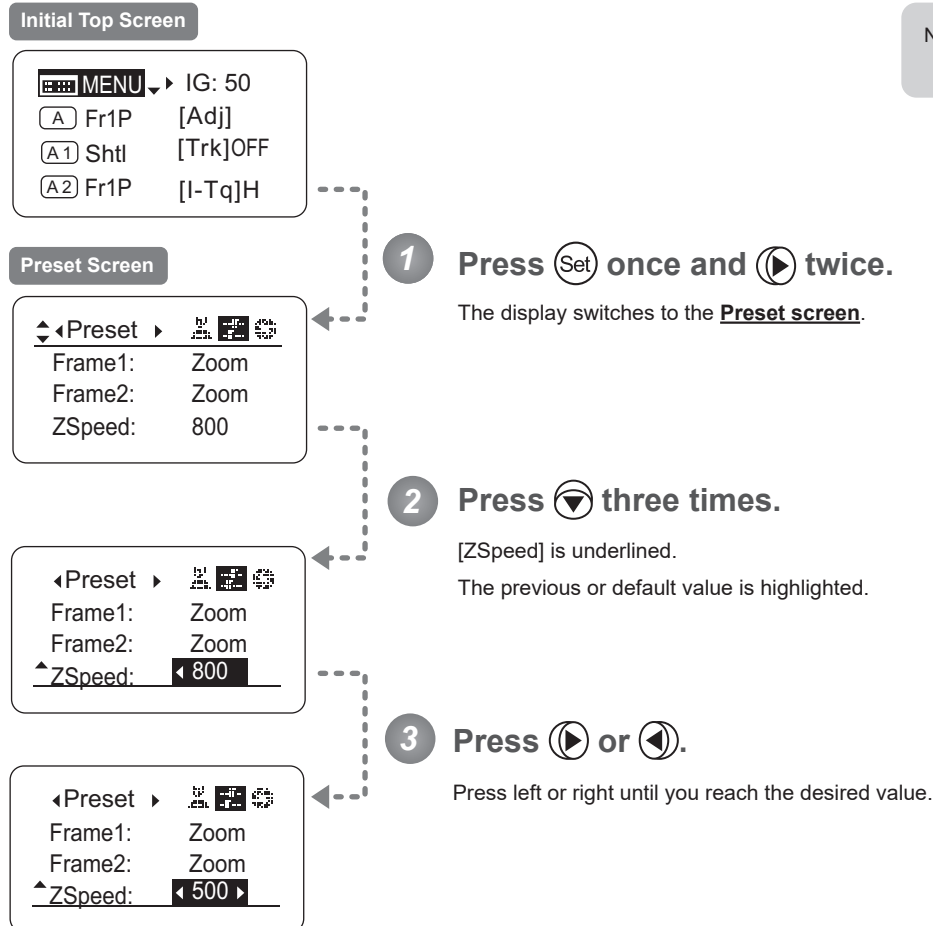

Note: Your specified values apply to both Fr1P and Fr2P.

Options	1	to	^(D) 800
Description	Slowest		Fastest

(D): Default value



3.2.4 Iris Screen Settings

The following setting items can be configured on the **Iris screen**.

Specifying Iris Gain

(1) Specifying Auto Iris Gain

Top

(2) Specifying Remote Iris Gain

Specifying Iris Torque

Top

Iris Compensation ON/OFF

Iris Close Detection ON/OFF

Focus Demand Iris Control ON/OFF

Items labeled **Top** can also be modified from the **Top screen**.

Specifying Iris Gain

(1) Specifying Auto Iris Gain Top

Although this value is factory-set, it can be adjusted as needed.

To adjust the value, use either the auto iris gain adjustment trimmer (refer to the operation manual "Lens") or display operations. Regardless of the method of adjustment used, the most recent setting takes precedence.

The same auto iris gain value applies to all users.

Initial Top Screen

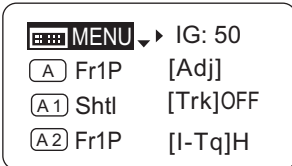

Iris Screen

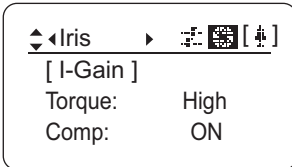

Screen A

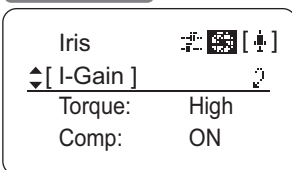

[I-Gain] Screen

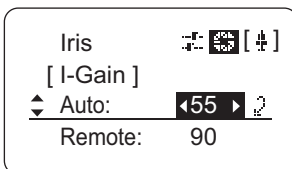
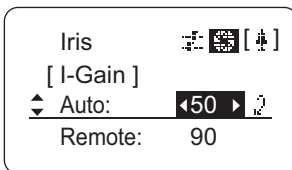
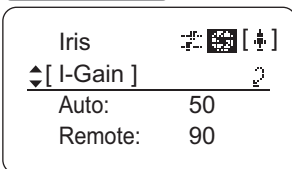

1 Press Set once and ▶ three times.

The display switches to the Iris screen.

2 Press ▼.

[I-Gain] is underlined.

3 Press Set.

The display switches to the [I-Gain] screen.

4 Press ▼.

[Auto] is underlined.
The previous or default value is highlighted.

5 Press ▶ or ◀.

Press left or right until you reach the desired function.

6 Press Set.

The display reverts to Screen A.

Note: Do the following when adjusting gain while checking iris operation.

- Confirm that the drive unit A/M switch is set to [Auto] mode.
- Set the camera iris mode to [Auto].

Note: As you look at the lens iris ring, set it to the position of maximum gain at which "focus hunting" does not occur.

Note: The current iris gain value is retained even if you reset other settings as described in "3.2.1 Resetting Values." For this reason, you will no longer be able to view the default setting. If necessary, make a note of the default setting before adjusting this value.

Options	01	to	99
Description	Minimum gain		Maximum gain

Default: Varies depending on the factory-set value, but corresponds to the value determined with the iris gain adjustment trimmer.



(2) Specifying Remote Iris Gain

Although this value is factory-set, it can be adjusted as needed.
The same remote iris gain value applies to all users.

Note: Do the following when adjusting gain while checking iris operation.
→ Confirm that the drive unit A/M switch is set to [Auto] mode.
→ Set the camera iris mode to [Remote].

Note: The current iris gain value is retained even if you reset other settings as described in "3.2.1 Resetting Values." For this reason, you will no longer be able to view the default setting. If necessary, make a note of the default setting before adjusting this value.

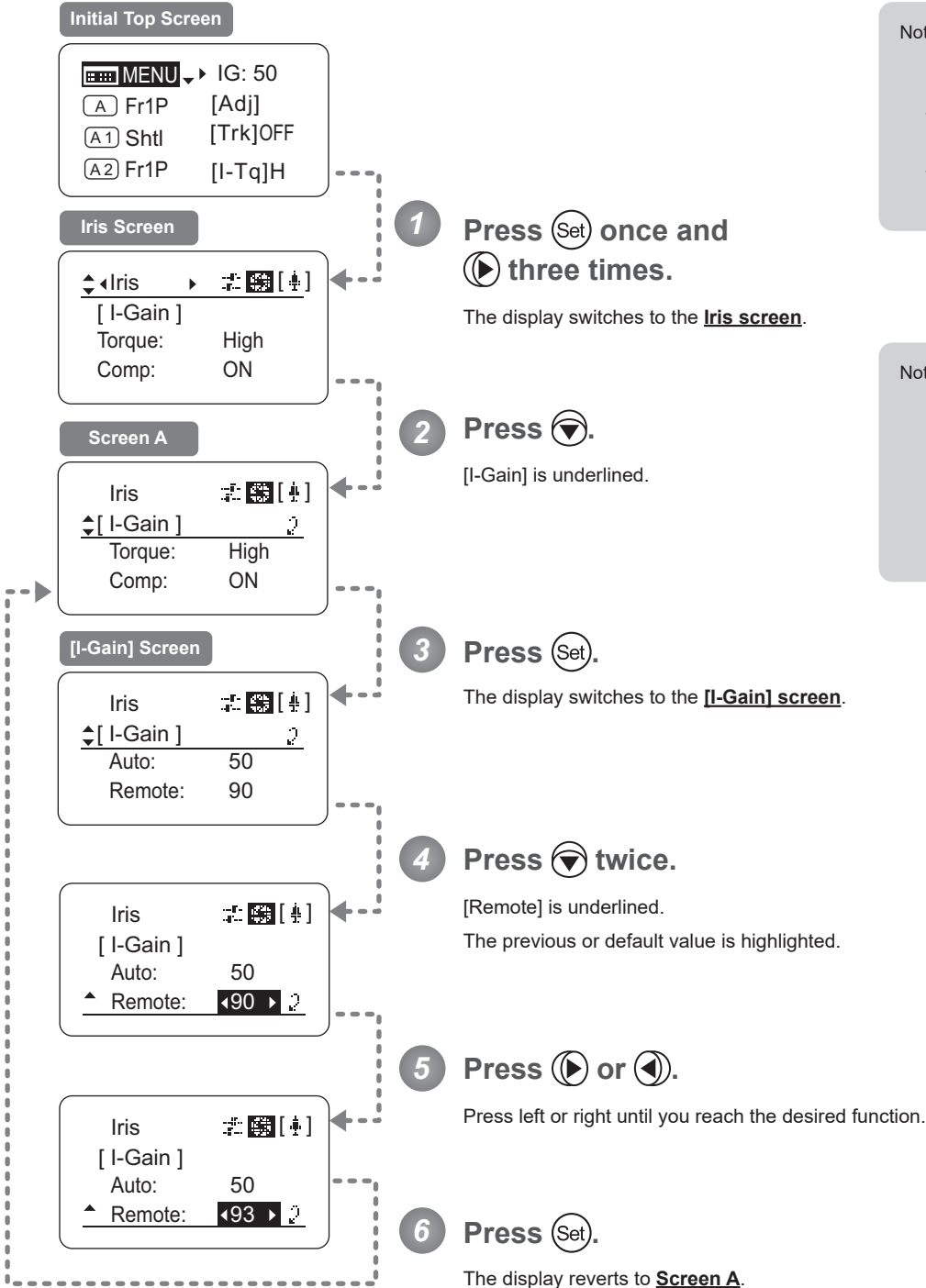

Options	01	to	99
Description	Minimum gain		Maximum gain

Default value: 90



Specifying Iris Torque Top

Specify the desired level of torque in manual control of the iris ring.

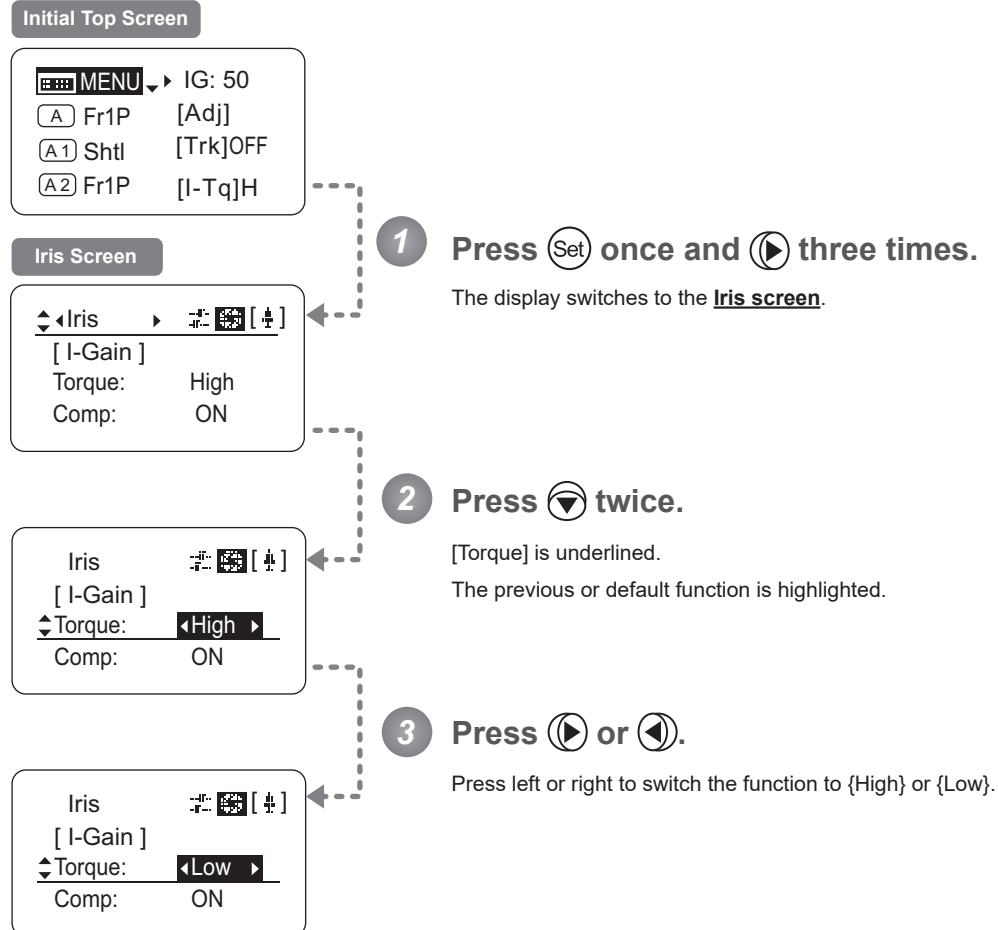

Options	^(D) High	Low
Description	High torque	Low torque

(D): Default value

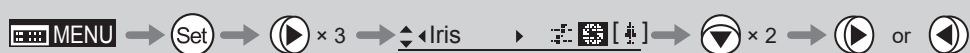

Iris Compensation ON/OFF

The amount of light decreases when an extender (1.5x) is used. Therefore, you can set a function that corrects the iris to the open side so as to maintain the amount of light.

Initial Top Screen

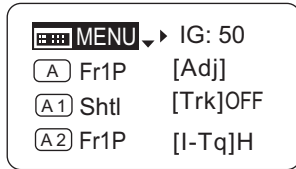

Iris Screen

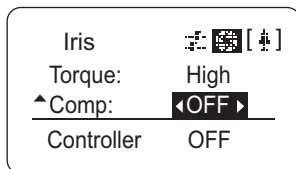
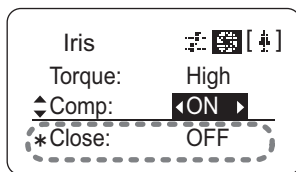
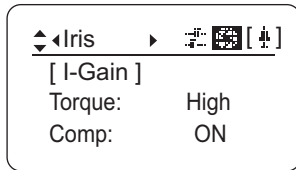

1 Press **Set** once and **▶** three times.

The display switches to the **Iris screen**.

2 Press **▼** three times.

[Comp] is underlined.

The previous or default function is highlighted.

3 Press **▶** or **◀**.

Press left or right to switch the function {ON} or {OFF}.

*: Displayed when {Comp} is set to ON.

Note: The iris may not fully close in some cases when the iris compensation is set to ON while an extender (1.5x) is used. If so, activate detection as described in "Iris Close Detection ON/OFF."

Options	^(D) ON	OFF
Description	Iris compensation	No iris compensation

(D): Default value

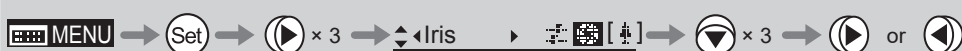

Iris Close Detection ON/OFF

The iris cannot be fully closed when correction is active and an extender (1.5×) is used. As a countermeasure, you can specify a function to detect iris close and close the iris as needed.

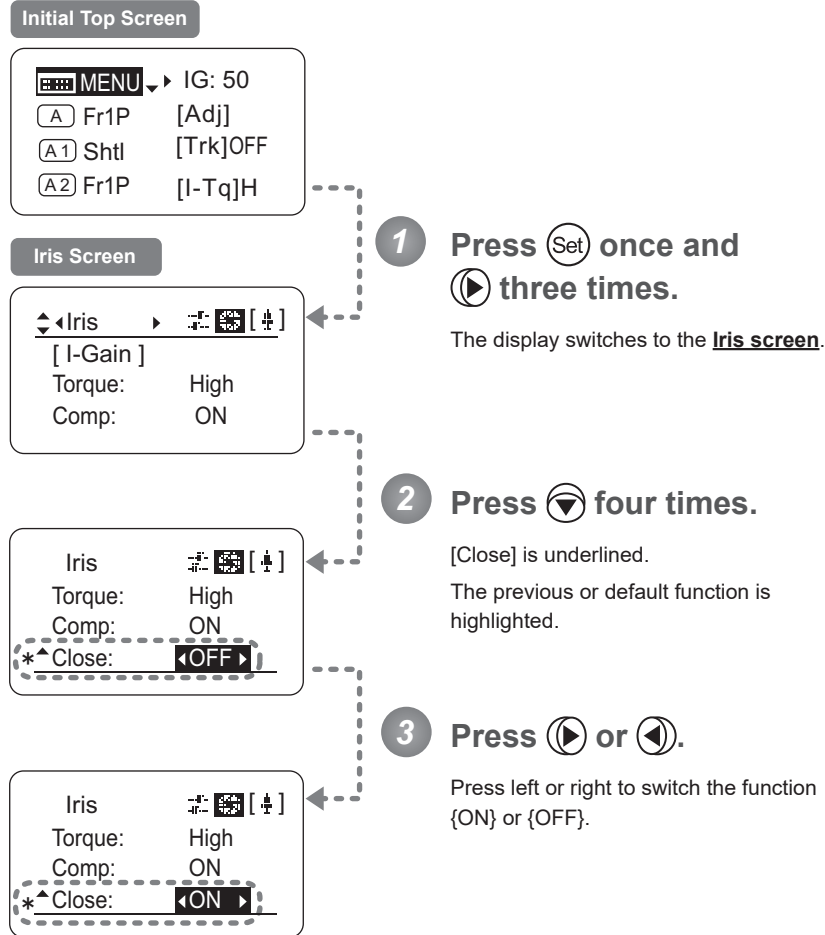

Note: With some cameras, iris compensation may conflict with iris control by the camera, preventing correct iris operation. If so, deactivate iris close detection.

*: Displayed when {Comp} is set to ON.

Note: Iris close is detected only when iris compensation is enabled.

Options	^(D) OFF	ON
Description	No close detection	Close detection

(D): Default value



Focus Demand Iris Control ON/OFF

Iris operations using a focus demand can be switched on or off.

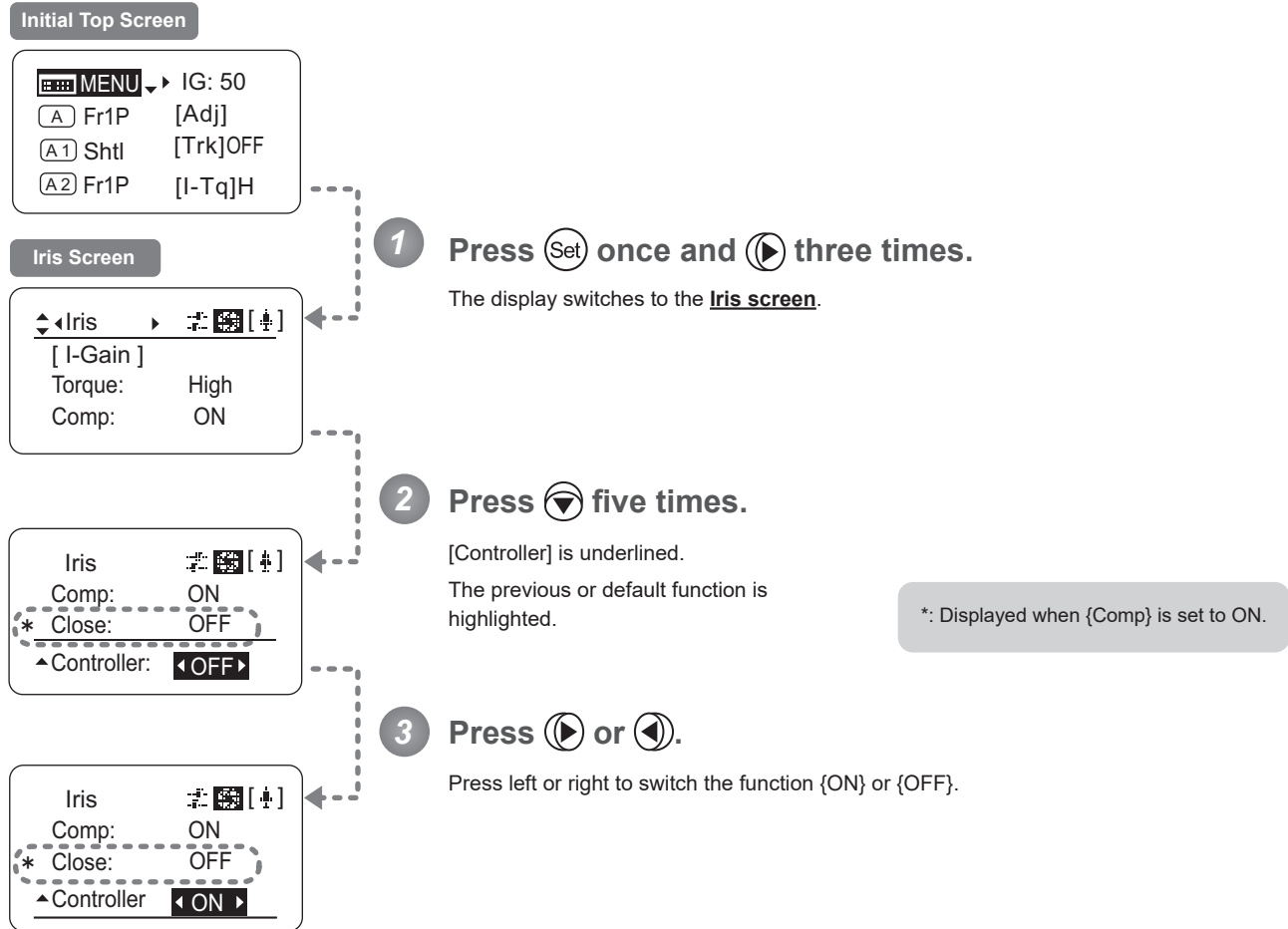

Options	ON	^(D) OFF
Description	Iris controlled with focus demand	Iris not controlled with focus demand

(D): Default value

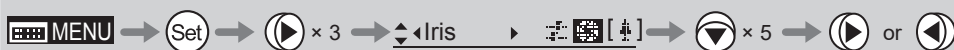

3.2.5 Zoom Screen Settings

The following setting items can be configured on the Zoom screen.

Specifying Seesaw Switch Responsiveness

Specifying Analog Demand Responsiveness

Demand-Based Zoom Speed Adjustment ON/OFF

Specifying Seesaw Switch Responsiveness

Configure the responsiveness of zoom speed adjustment in response to pressing the zoom seesaw switch.
 (Note: Another screen is displayed when this setting is configured.)

Initial Top Screen

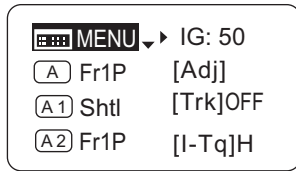

Zoom Screen

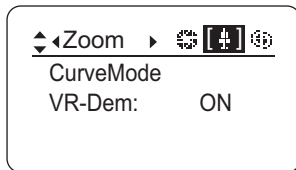

Screen A

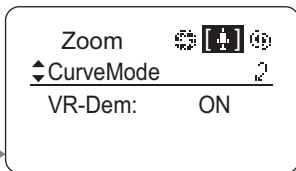

CurveMode Screen

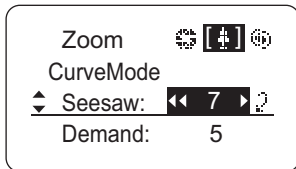
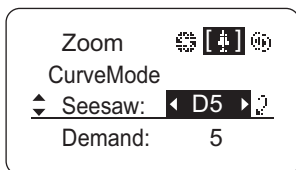
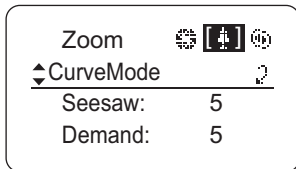

1 Press [Set] once and [Play] four times.

The display switches to the **Zoom screen**.

2 Press [Down].

[CurveMode] is underlined.

3 Press [Set].

The display switches to the **CurveMode screen**.

4 Press [Down].

[Seesaw] is underlined.
 The previous or default value is highlighted.

5 Press [Right] or [Left].

Press left or right until you reach the desired function.

6 Press [Set].

The display reverts to **Screen A**.

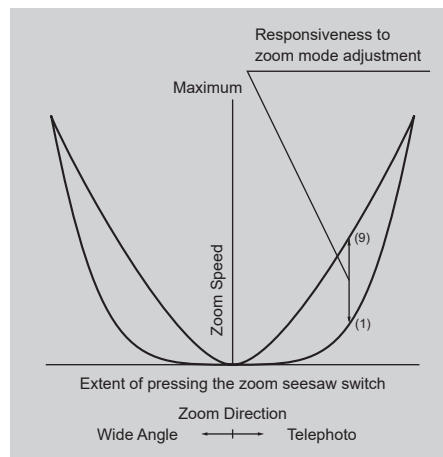

Options	1	2	3	4	(D) 5	6	7	8	9
---------	---	---	---	---	-------	---	---	---	---

(D): Default value

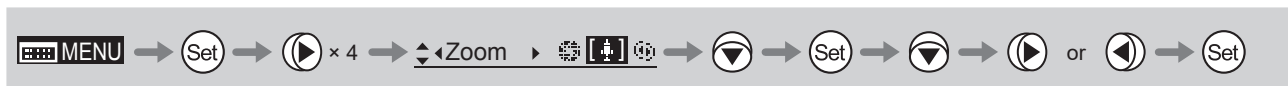

Specifying Analog Demand Responsiveness

Configure the responsiveness of zoom speed adjustment in response to pressing the analog demand thumb ring.
 (Note: Another screen is displayed when this setting is configured.)

Initial Top Screen

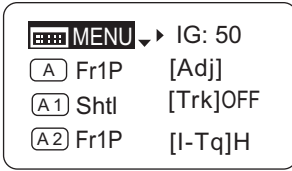

Zoom Screen

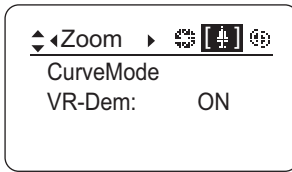

Screen A

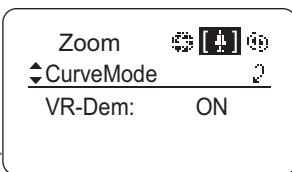

CurveMode Screen

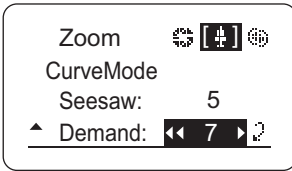
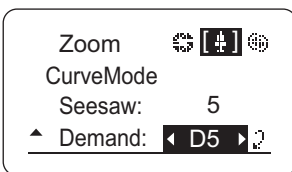
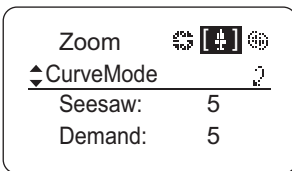

1 Press **Set** once and **▶** four times.

The display switches to the **Zoom screen**.

2 Press **▼**.

[CurveMode] is underlined.

3 Press **Set**.

The display switches to the **CurveMode screen**.

4 Press **▼** twice.

[Demand] is underlined.
 The previous or default value is highlighted.

5 Press **▶** or **◀**.

Press left or right until you reach the desired function.

6 Press **Set**.

The display reverts to **Screen A**.

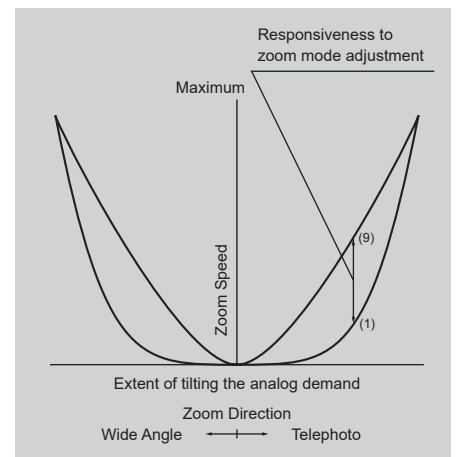

Options	1	2	3	4	(D) 5	6	7	8	9
---------	---	---	---	---	-------	---	---	---	---

(D): Default value



Demand-Based Zoom Speed Adjustment ON/OFF

Enable or disable adjustment of the maximum drive unit zoom speed based on the zoom demand.

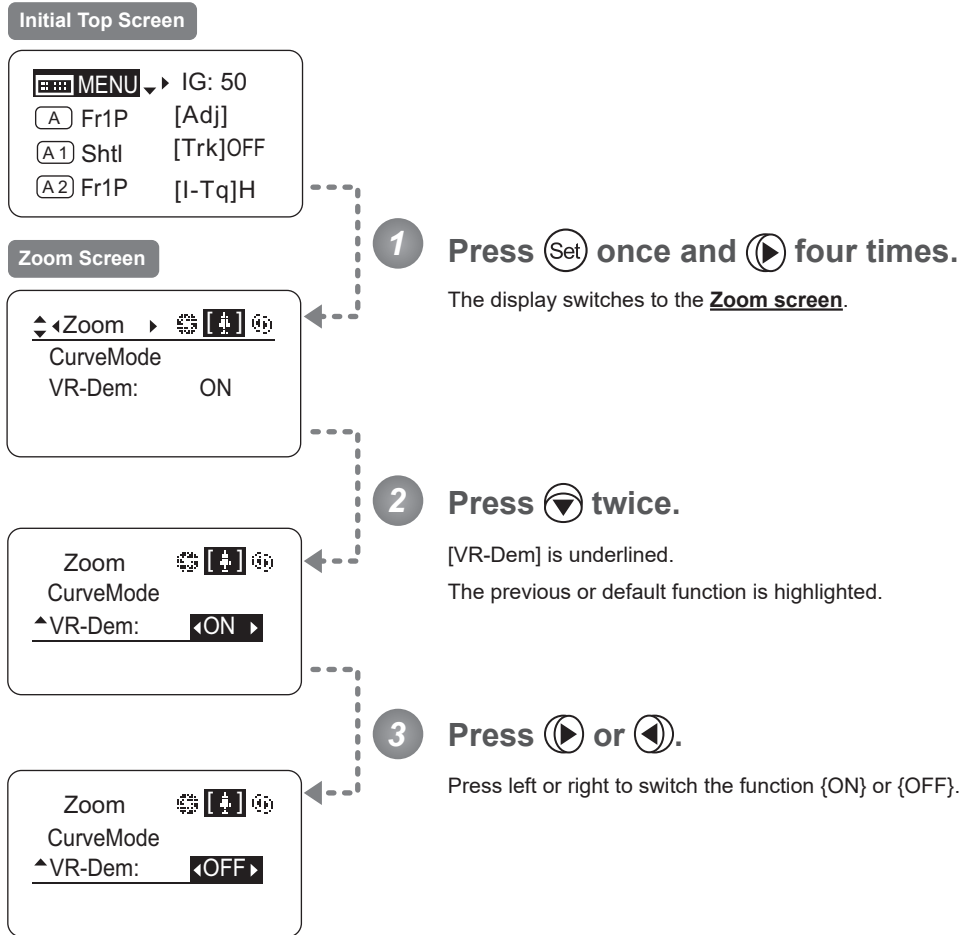

Options	^(D) ON	OFF
Description	Enabled	Disabled

(D): Default value

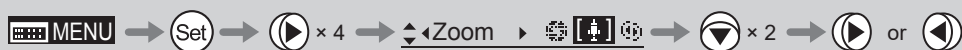

3.2.6 Focus Screen Settings

The following setting items can be configured on the **Focus screen**.

Specifying Focus Demand Responsiveness

Specifying Focus Demand Responsiveness

Specify responsiveness in analog focus demand operations as needed.

Note: These settings take effect when the curve selection switch on the focus demand is set toward FAR.

Initial Top Screen

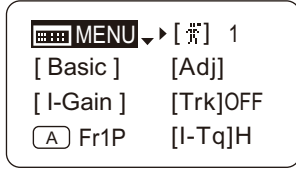

Focus Screen

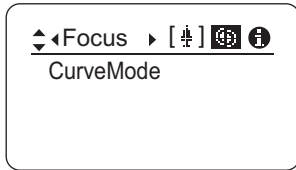

Screen A

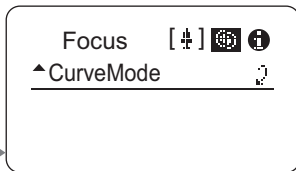

CurveMode Screen

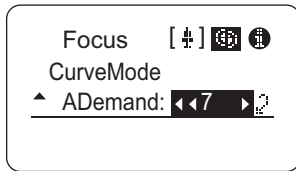
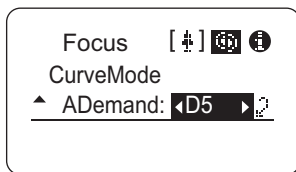
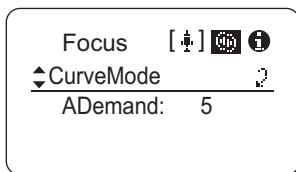

1 Press **Set** once and **Left Arrow** three times.

The display switches to the **Focus screen**.

2 Press **Down Arrow**.

[CurveMode] is underlined.

3 Press **Set**.

The display switches to the **CurveMode screen**.

4 Press **Down Arrow**.

[ADemand] is underlined.
The previous or default value is highlighted.

5 Press **Right Arrow** or **Left Arrow**.

Press left or right until you reach the desired function.

6 Press **Set**.

The display reverts to **Screen A**.

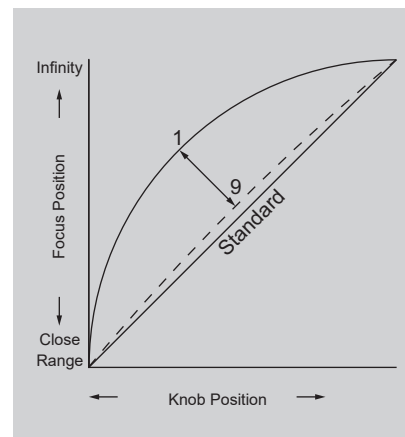

Options	1	to	9
Description	Large curve		Small curve

Default value: 5



3.2.7 Info Screen Settings

The following setting items can be configured on the **Info screen**.

Checking Serial Numbers

Specifying the 3D Function (For information on specifying the 3D function, see the instruction manual of the BC-100 3D cable.)

Specifying Encoder Output

Serial Communication with Camera ON/OFF

Specifying the Input Route for Command Signals from the Camera

Specifying the / μ Technology Distance Unit

Checking Lens–Drive Unit Communication

Checking Serial Numbers

Check lens and drive unit serial numbers as needed.

Initial Top Screen

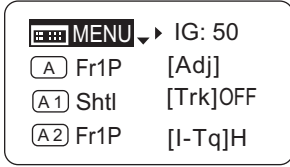

Info Screen

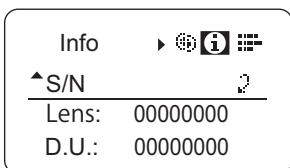
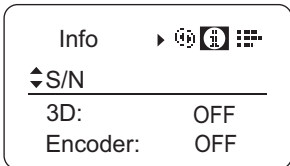
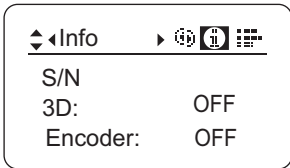

1 Press **Set** once and **Left Arrow** twice.

The display switches to the Info screen.

2 Press **Down Arrow**.

[S/N] is underlined.

3 Press **Set**.

The lens and drive unit serial numbers are displayed.

Note: The serial number of the lens is not displayed when no power is being supplied to the lens from the camera mount.

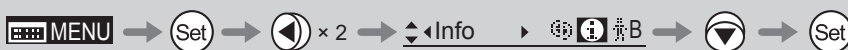

Specifying Encoder Output

Enable or disable encoder output as needed. Enabling output enables virtual connector output. For details, contact Canon or your dealer.

Initial Top Screen

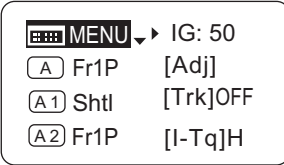

Info Screen

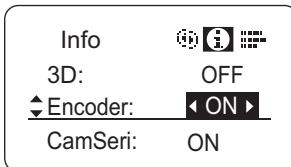
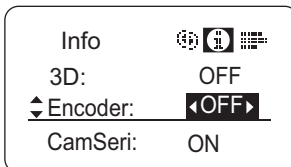
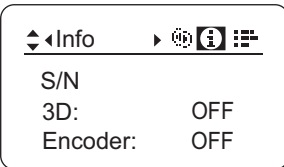

1 Press **Set** once and **Left Arrow** twice.

The display switches to the **Info screen**.

2 Press **Down Arrow** three times.

[Encoder] is underlined.

3 Press **Right Arrow** or **Left Arrow**.

Press left or right to switch the function {ON} or {OFF}.

Options	^(D) OFF	ON
Description	Output disabled	Output enabled

(D): Default value

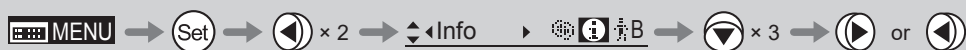

Serial Communication with Camera ON/OFF

Two types of camera–lens interfaces are available: analog control or control via serial communication. This setting enables you to switch between auto control detection and analog control.

By default, this setting is ON, enabling auto detection of whether serial or analog control is used.

To restrict the interface to analog control, set it to OFF.

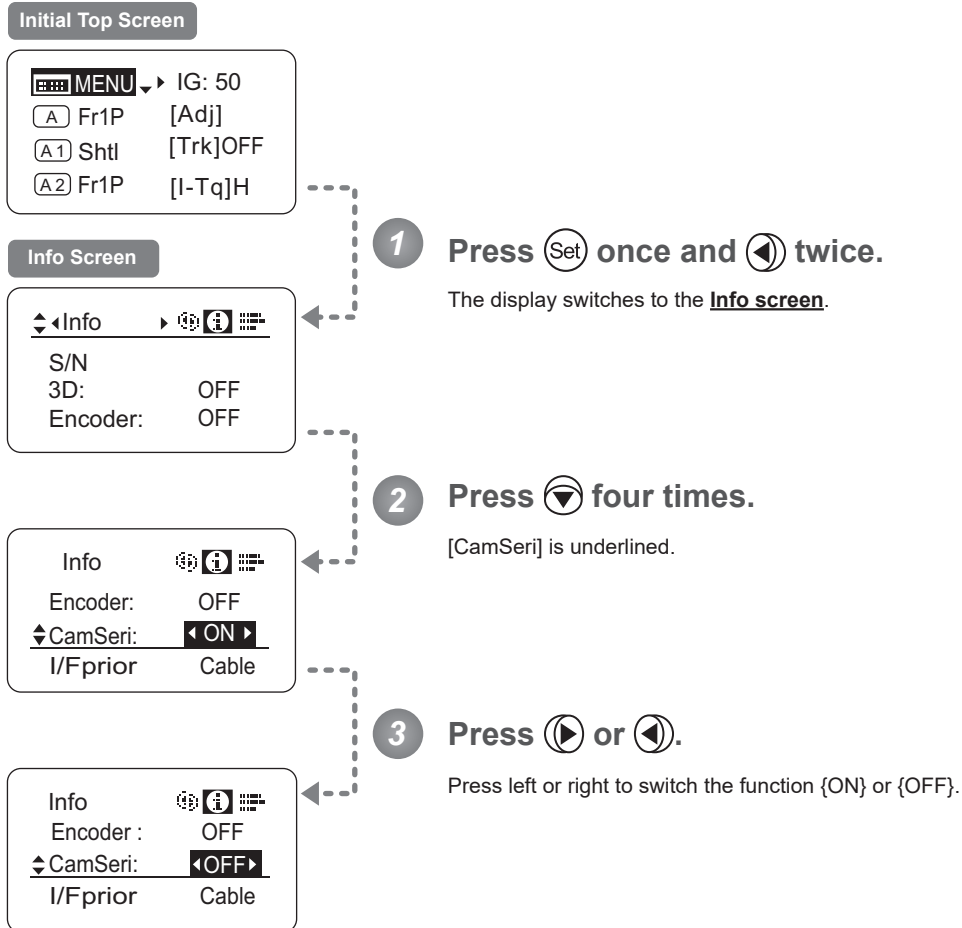

Options	^(D) ON	OFF
Description	Serial communication with the camera Enabled	Serial communication with the camera Disabled

(D): Default value

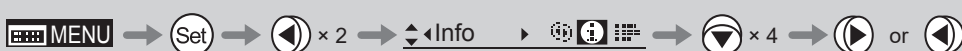

Specifying the Input Route for Command Signals from the Camera

There are two input routes for command signals from the camera: via the mount and via the 12-pin cable. This setting specifies the input route for command signals from the camera. The default setting is "Mount," and in this case command signals received via the mount are given priority.

However, the command signals via the 12-pin cable are received automatically if no command signals are input via the mount. When the "Cable" setting is selected, only command signals received via the 12-pin cable are used.

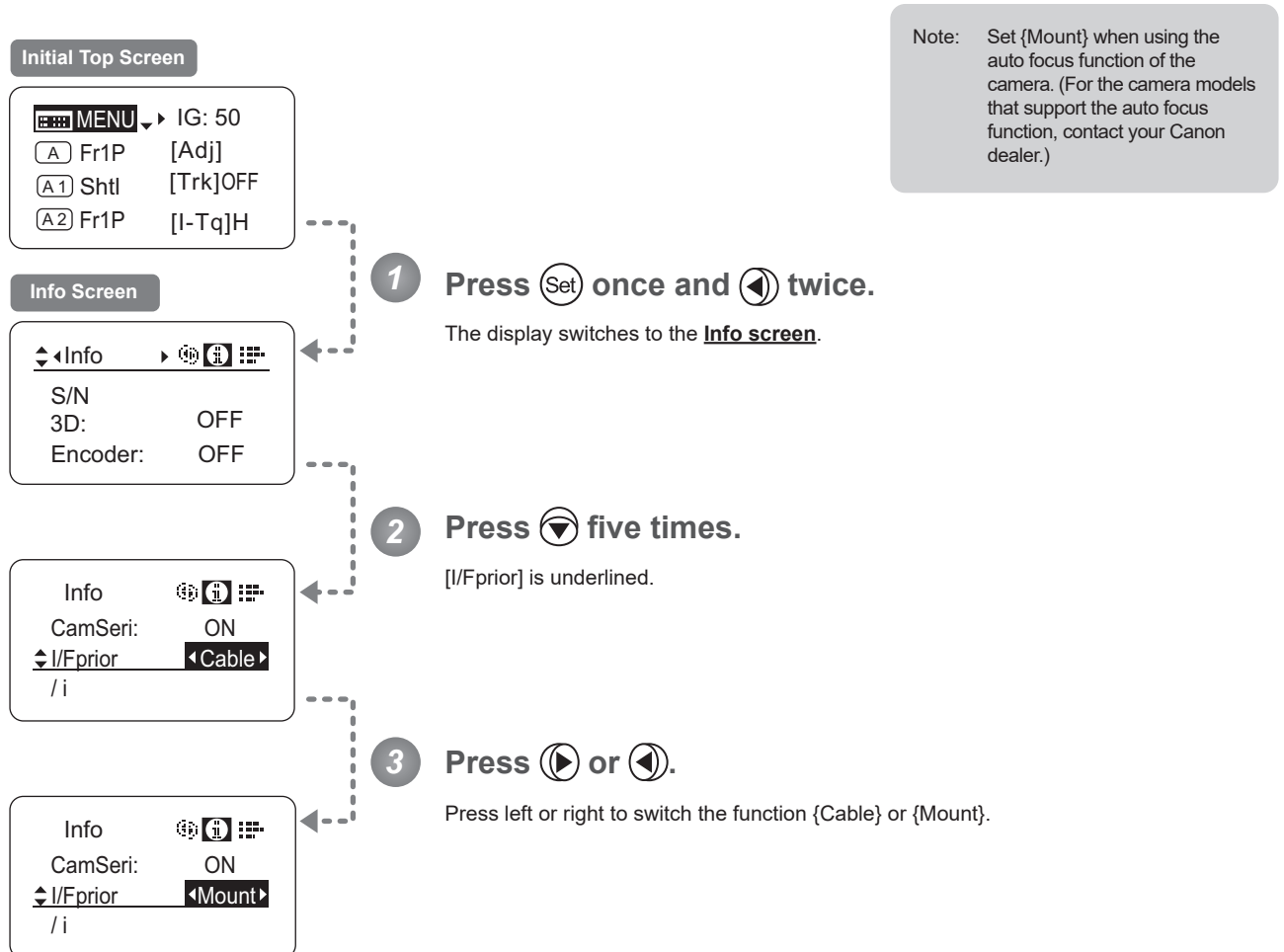

Options	^(D) Mount	Cable
Description	Via mount	Via 12-pin cable

(D): Default value



Specifying the $\frac{1}{i}$ Technology Distance Unit

When $\frac{1}{i}$ Technology is used (only when a PL mount camera is attached), it is possible to specify the initial setting for the unit (feet or meters) used to express distances in information sent to the camera. Accordingly, information sent for the actual subject distance, hyperfocal distance, subject distance at close range and infinity, and entrance pupil position is expressed in the specified unit.

Note

Any distance unit set on the camera takes precedence.

$\frac{1}{i}$ is trademark of Cooke Optics Limited.

Initial Top Screen

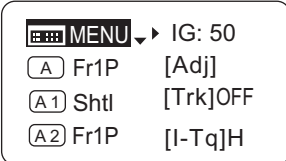

Info Screen

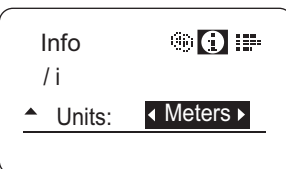
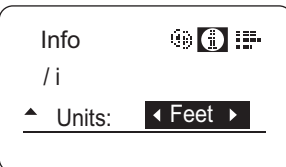
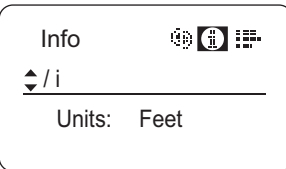
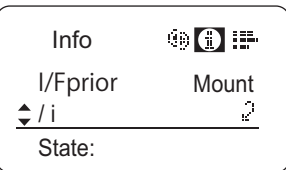
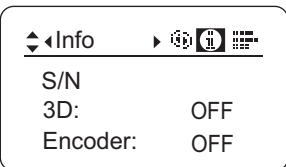

1 Press **Set** once and **Left Arrow** twice.

The display switches to the **Info screen**.

2 Press **Down Arrow** six times.

[/ i] is underlined.

3 Press **Set**.

4 Press **Down Arrow**.

[Units] is underlined.

The previous or default value is highlighted.

5 Press **Right Arrow** or **Left Arrow**.

Press left or right to switch the function {Feet} or {Meters}.

Options	^(D) Feet	Meters
Description	Expressed in feet	Expressed in meters

(D): Default value



Checking Lens–Drive Unit Communication

View the status of communication between the lens and drive unit as follows.

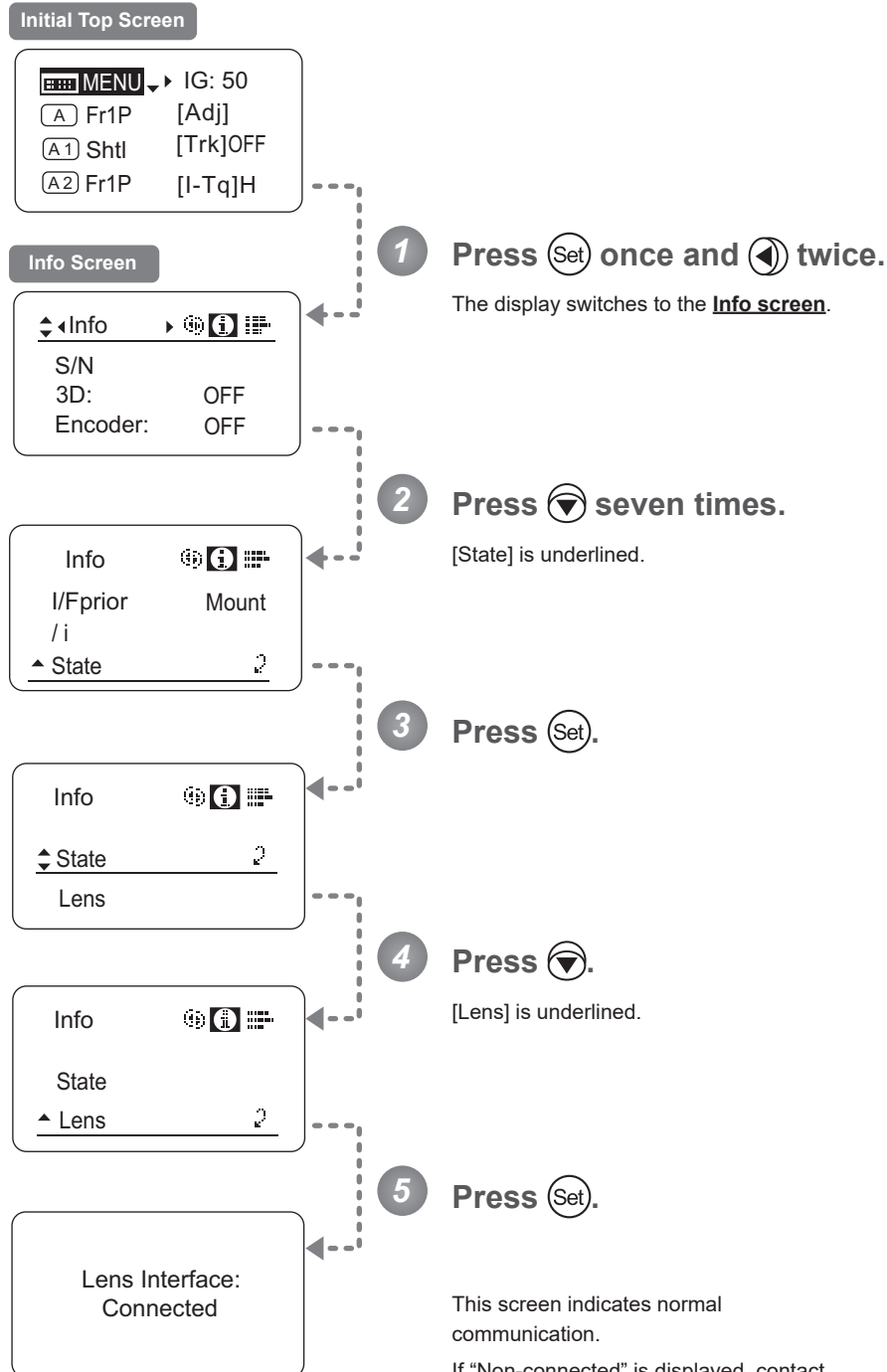

3.2.8 Fol. Screen Settings

The following setting items can be configured on the **Fol. screen**.

Viewing Lens Follow Settings (Iris, Zoom, Focus)

Viewing Lens Follow Settings (Iris, Zoom, Focus)

Indicates values in the full range of mechanical iris, zoom, and focus operations, expressed as relative values in the range of 0–1000.

Initial Top Screen

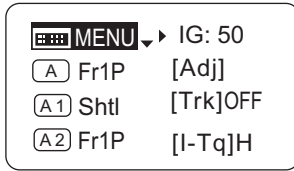

Fol. Screen

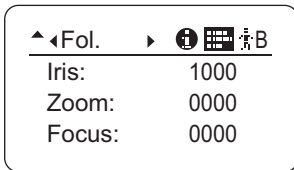

1

Press **Set** and then **◀**.

The display switches to the **Fol. screen**, showing relative follow iris, zoom, and focus values.

Note: As long as the **Fol. screen** is shown, the display will not turn off automatically after 2 minutes if left idle. To turn off the display, press the Display switch.



3.3 List of Settings

		Default Value	Options	Page
<div style="border: 1px solid black; padding: 2px; display: inline-block;">Top</div>				
	MENU		To *1 on the next page	
	IG	50	01-99	
	[A]	Fr1P	VTR / RET / Fr1P / Fr1F / Fr2P / Fr2F / Sped / Shtl / NON	
	[Adj]	n	y / n	
	[A 1]	Shtl	VTR / RET / Fr1P / Fr1F / Fr2P / Fr2F / Sped / Shtl / NON	
	[Trk]	OFF	OFF / ON	
	[A 2]	Fr1P	VTR / RET / Fr1P / Fr1F / Fr2P / Fr2F / Sped / Shtl / NON	
	[I-Tq]	H	H / L	
	[Z.M.]			
			To *2 on the next page	

Escape Operation	Jump to user 0 setting status	Hold down both the Display switch and Set key for at least 2 seconds.	
------------------	-------------------------------	---	--

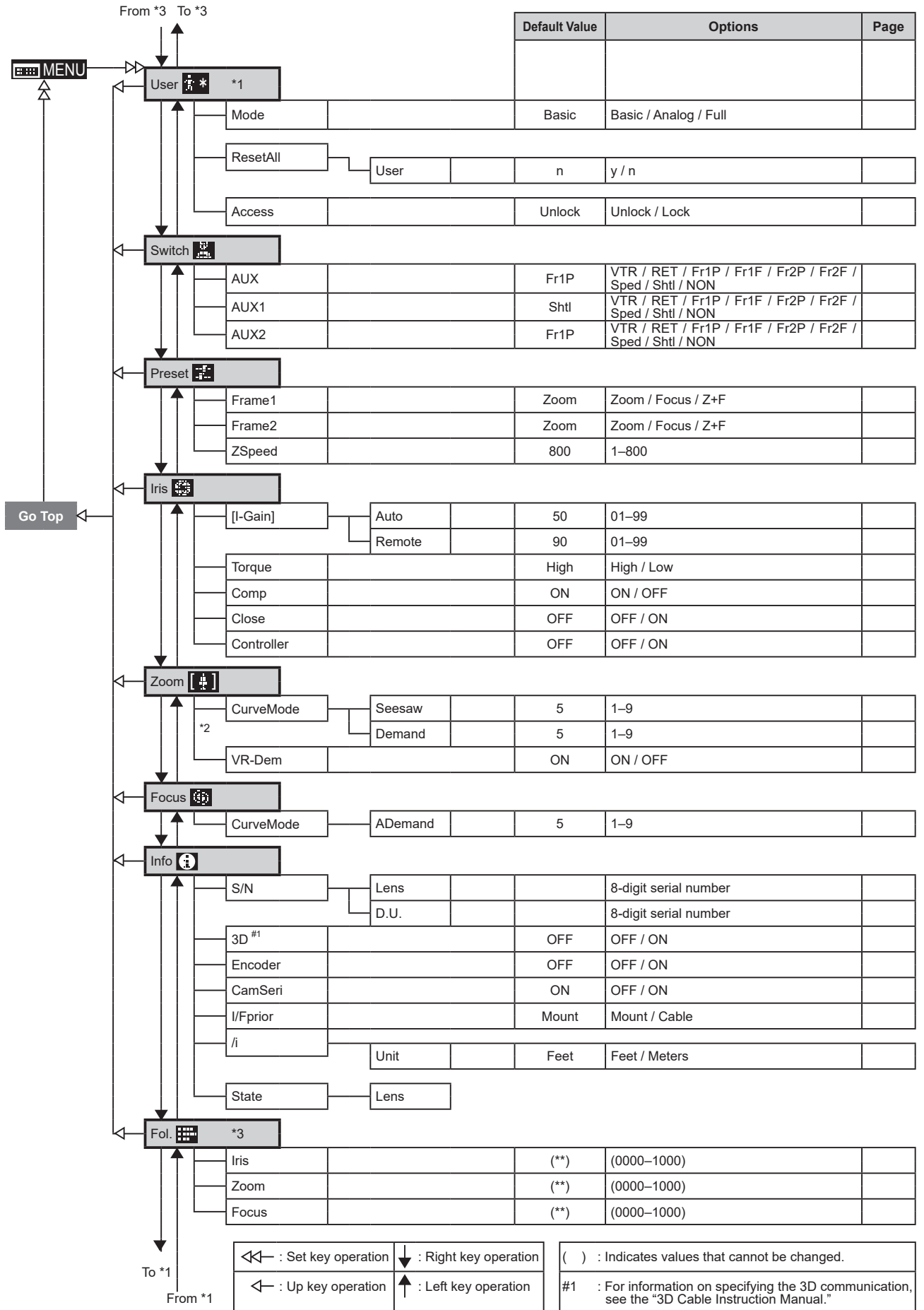

Memo

4

Operation in Full Mode

4. Operation in Full Mode

4.1 Configuration from the Top Screen

To access the **Top screen**, press the Display switch.

A total of 15 items can be configured on the **Top screen** in Full mode. The first screen displayed is referred to as the **Initial Top screen**. Status of some items can be checked simply by accessing this screen.

Initial Top Screen in Full Mode

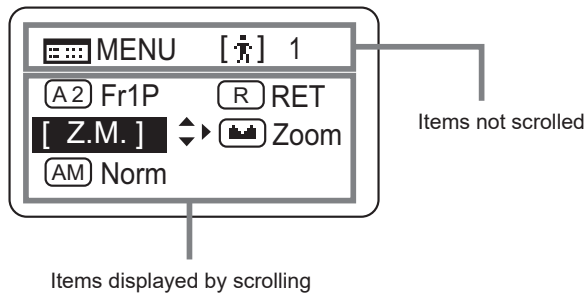
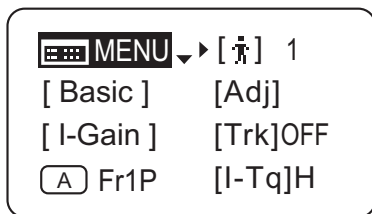

4.1.1 Selecting Full Mode

Basic mode is the default mode, but Full mode can be accessed as follows.

Switching from Basic to Full Mode

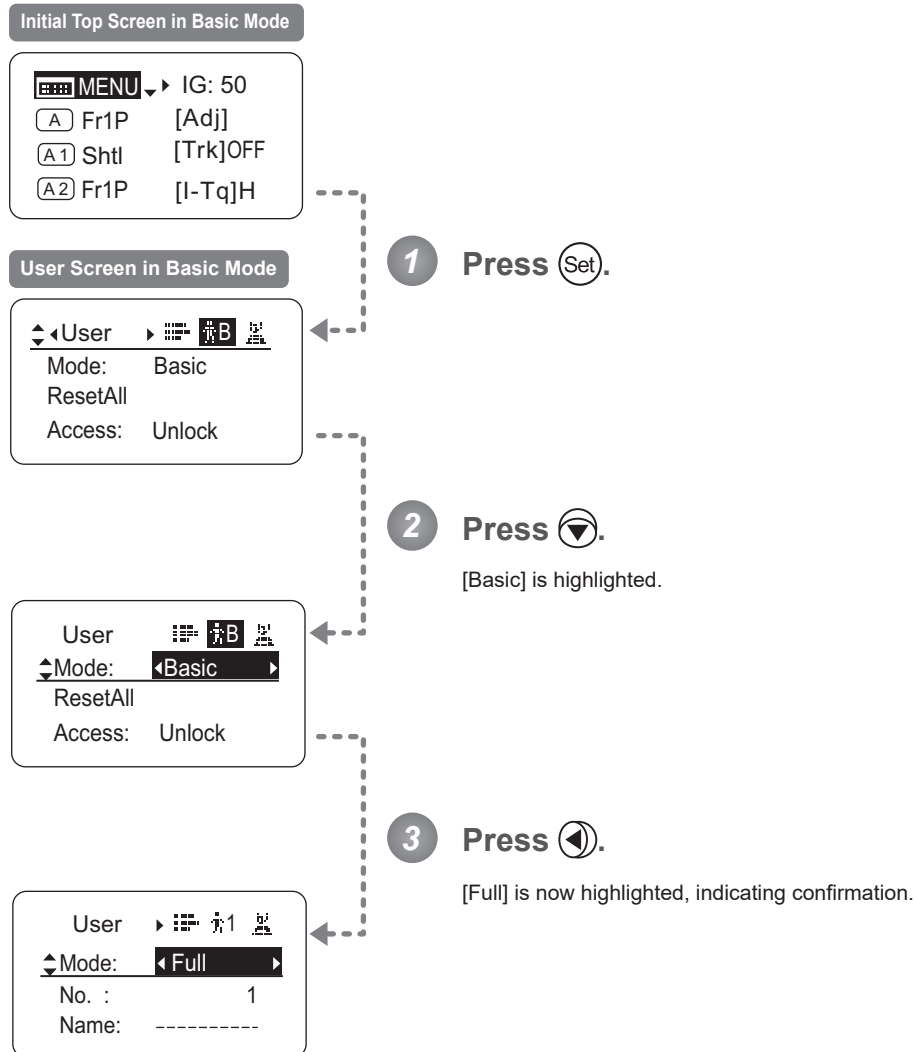

4.1.2 Top Screen

A total of 15 items can be configured on the **Top screen** in Full mode, and 8 items are shown on the **Initial Top screen**. The other 7 can be accessed by pressing down to scroll down the screen.

(See the following figure.)

Status of some items can be checked simply by accessing this screen. (Shown in the figure below.¹⁾)

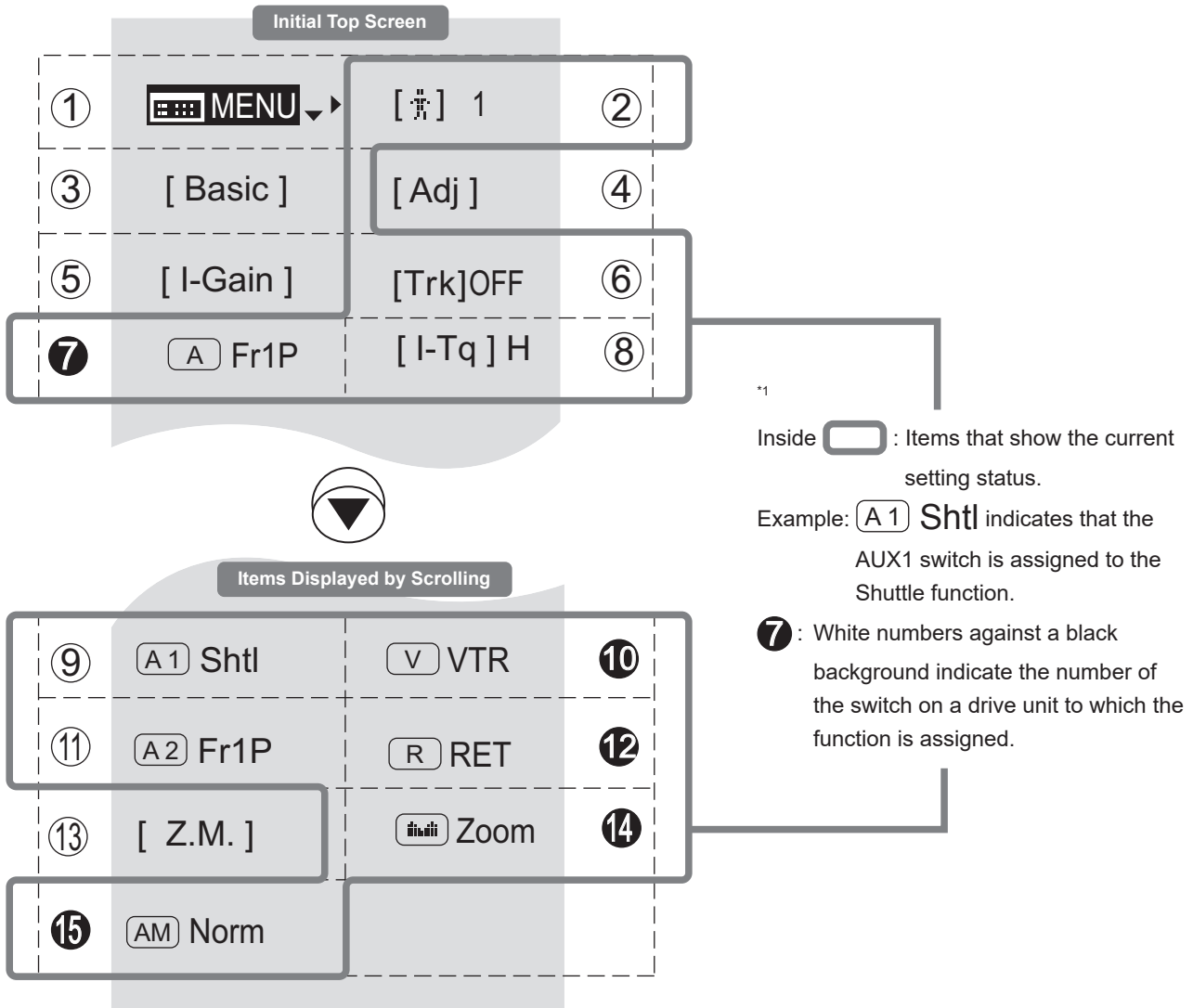

①  **Menu screen**

See “4.2 Configuration from the Menu Screen.”

②  **User**

Adjust settings for up to ten users (0–9), to distinguish settings by user. Switch users from this screen, either to use or change the settings.

See “4.1.3 Switching Users.”

③ [Basic] **Switching to Basic Mode**

Switch to Basic mode as needed.

See “4.1.4 Switching to Basic Mode.”

④ [Adj] **Mechanical end auto-adjustment**

Perform automatic adjustment of the mechanical end in zoom, focus, and iris operations on the lens and drive unit.

See “4.1.5 Auto-Adjusting the Mechanical End.”

⑤ [I-Gain] **Iris gain**

Adjust the auto iris gain or the remote iris gain value as needed.

See “4.1.6 Specifying Iris Gain.”

⑥ [Trk] **Zoom tracking**

Switch to ON when using zoom tracking.

See “4.1.7 Zoom Tracking ON/OFF.”

⑦  **AUX switch**

By default, the AUX switch for a drive unit is assigned to the “Frame Preset 1” function, but it can be reassigned as needed.

See “4.1.8 Assigning Functions to the AUX Switch.”

⑧ [I-Tq] **Iris torque**

Adjust the level of torque in manual control of the iris ring as needed.

See “4.1.9 Specifying Iris Torque.”

⑨  **AUX1 switch**

By default, the AUX1 switch for a zoom demand is assigned to the {Shuttle} function, but it can be reassigned as needed.

See “4.1.10 Assigning Functions to the AUX1 Switch.”

⑩  **VTR switch**

By default, the VTR switch for a drive unit is assigned to the {VTR} function, but it can be reassigned as needed.

See “4.1.11 Assigning Functions to the VTR Switch.”

⑪  **AUX2 switch**

By default, the AUX2 switch for a zoom demand is assigned to the {Frame Preset 1} function, but it can be reassigned as needed.

See “4.1.12 Assigning Functions to the AUX2 Switch.”

⑫  **RET switch**

By default, the RET switch for a drive unit is assigned to the {Return} function, but it can be reassigned as needed.

See “4.1.13 Assigning Functions to the RET Switch.”

⑬ [Z.M.] **Zoom curve mode**

Adjust zoom speed in response to pressing the zoom seesaw switch or tilting the analog demand thumb ring.

See “4.1.14 Specifying Zoom Curve Mode.”

⑭  **Seesaw**

Enable iris control using the zoom seesaw switch.

See “4.1.15 Assigning Functions to the Seesaw.”

⑮  **Iris A/M switch**

Adjust movement of the iris A/M switch on the drive unit.

See “4.1.16 Specifying Iris A/M Switch.”

4.1.3 Switching Users



Settings for users 0–9 can be configured in Full mode.

User 1–9

Configure advanced settings for each user needed. Settings for the users can then be saved.

User 0

User 0 is the default user. Thus, for this user you can adjust settings temporarily but not save them.

Setting information is cleared when you switch to users 1–9 or turn the lens off. User 0 is used if you perform an escape operation. For details, see “4.1.17 Escape Operation.” Selecting user 0 restores the default settings, except for the auto and remote iris gain values and encoder output setting.

Switch to the desired user (0–9) from the **Top screen**.

Configure advanced settings for these users from the **Menu screen**. See “4.2 Configuration from the Menu Screen.”

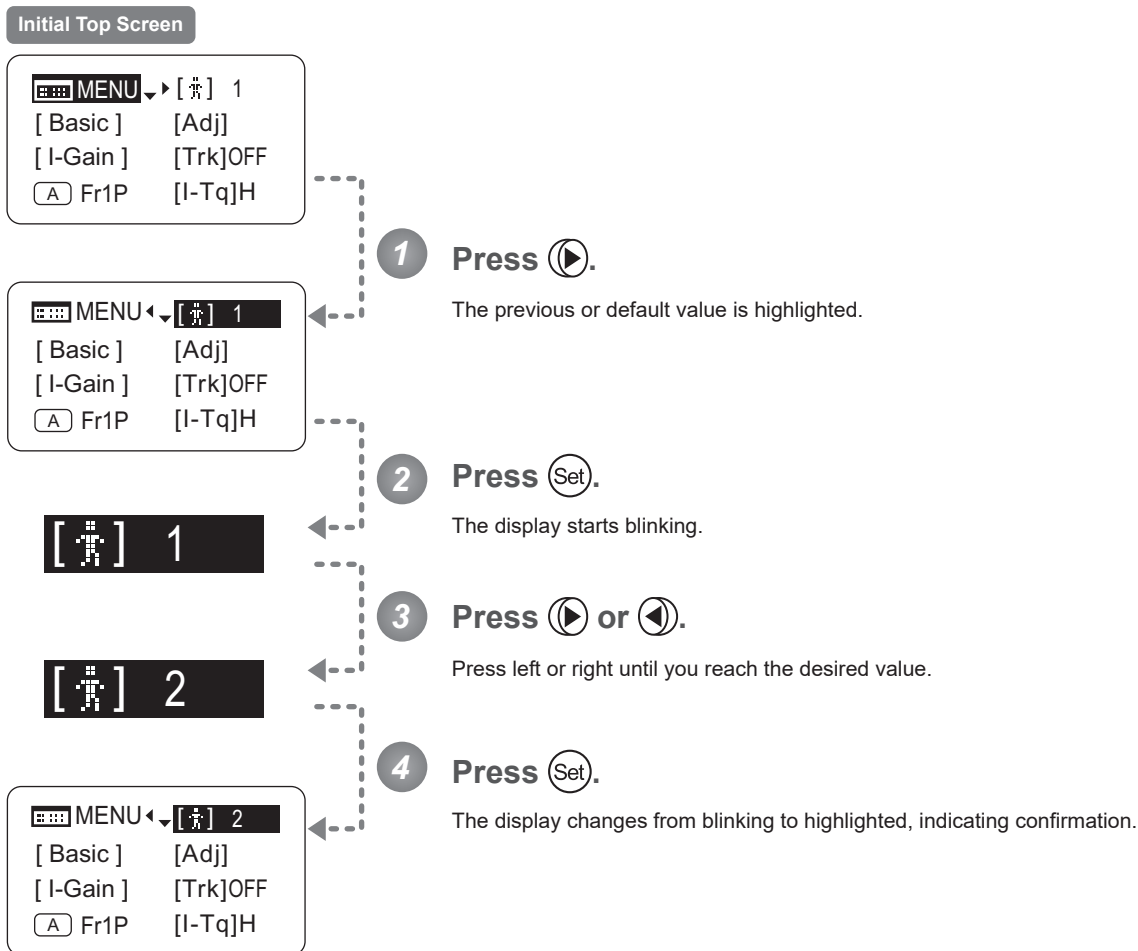

Options	0	^(D) 1	2	3	4	5	6	7	8	9
Save Settings	Not supported Although settings cannot be saved, they can be changed temporarily. Switching users or turning the lens off will restore default values.	Can be saved for each user								

(D): Default value



4.1.4 Switching to Basic Mode

[Basic]

Switch to Basic mode from the **Top screen** as needed.

Switching from Full to Basic Mode

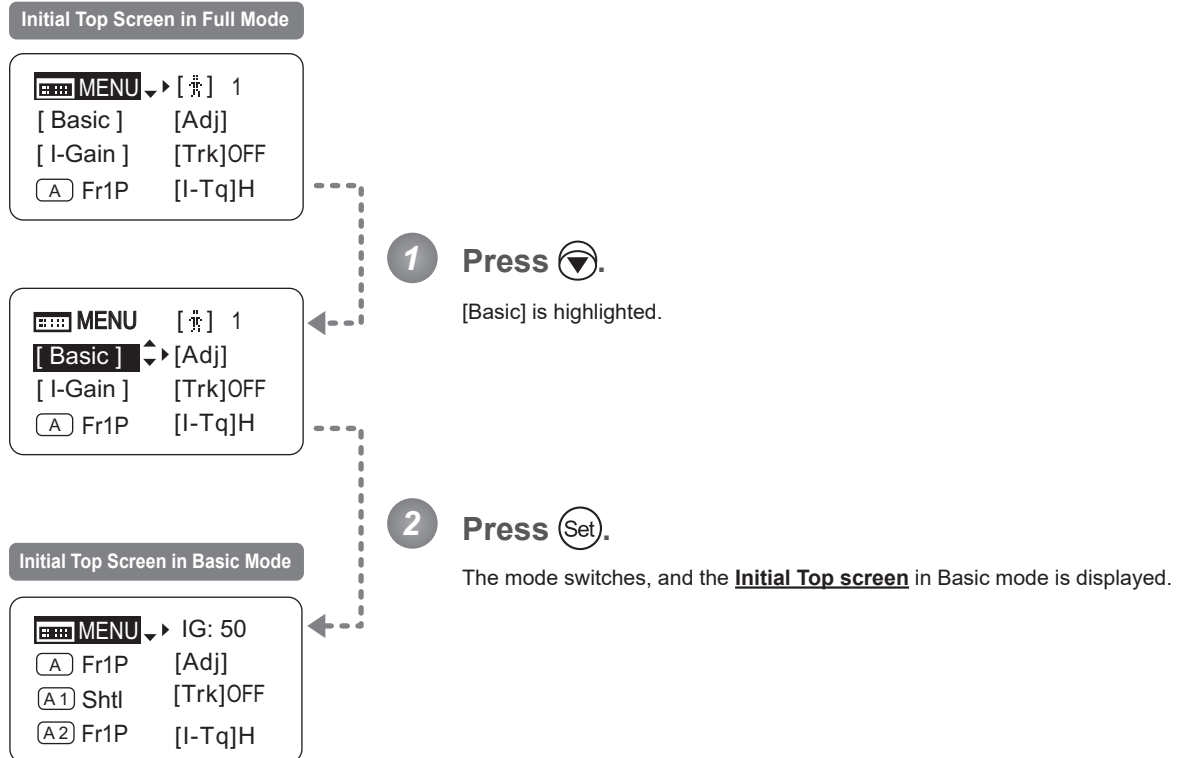

4.1.5 Auto-Adjusting the Mechanical End

[Adj]

Perform automatic adjustment of the mechanical end in zoom, focus, and iris operations on the lens and drive unit.

Note

If “Auto-Adjustment: Error/Lens Interface: Non-Connected” is displayed after adjustment, contact Canon or your dealer.

Initial Top Screen

```

MENU ▾ [ 1
[ Basic ] [Adj]
[ I-Gain ] [Trk]OFF
(A) Fr1P [I-Tq]H
  
```

Screen A

```

MENU [ 1
[ Basic ] ◀ [Adj]
[ I-Gain ] [Trk]OFF
(A) Fr1P [I-Tq]H
  
```

```

Lens
AutoAdjust
OK? y/n
  
```

```

Auto-Adjustment:
Succeeded
Lens Interface:
Connected
  
```

1 Press  and then .

Your selection is now highlighted.

2 Press .

The display switches to the **Auto-Adjustment screen**.

3 Press  and then .

Adjustment now begins.

During adjustment, the screen blinks.

After this, adjustment is finished.

Press  after adjustment to return to **Screen A**.



4.1.6 Specifying Iris Gain

[I-Gain]

Specifying Auto Iris Gain

Although this value is factory-set, it can be adjusted as needed.

To adjust the value, use either the auto iris gain adjustment trimmer (refer to the operation manual "Lens") or display operations. Regardless of the method of adjustment used, the most recent setting takes precedence.

The same auto iris gain value applies to all users, regardless of the current user. Thus, there is no need to switch users in advance. Unlike most other setting adjustments, any changes to this setting also apply to user 0.

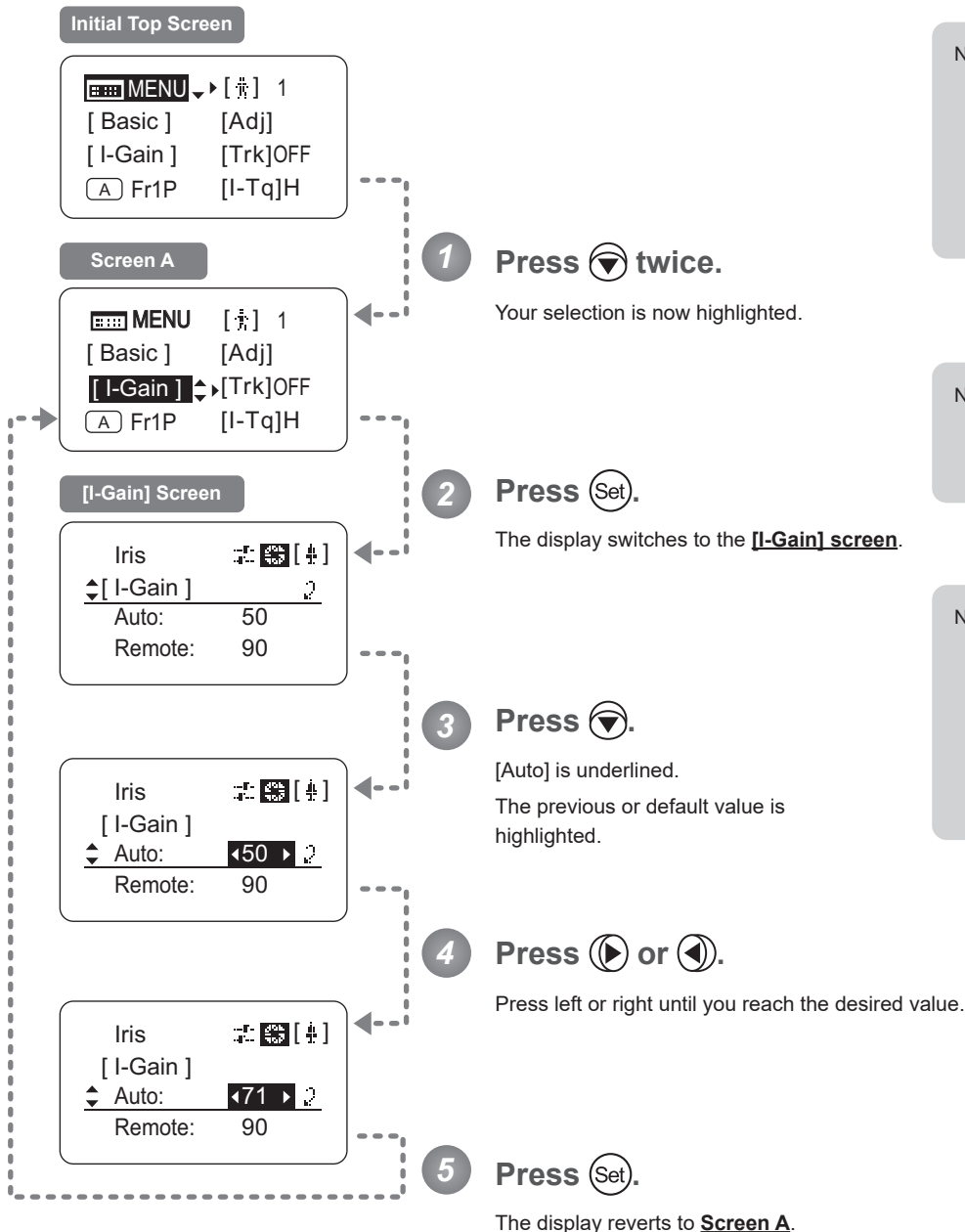

Note: Do the following when adjusting gain while checking iris operation.

- Confirm that the drive unit A/M switch is set to [Auto] mode.
- Set the camera iris mode to [Auto].

Note: As you look at the lens iris ring, set it to the position of maximum gain at which "focus hunting" does not occur.

Note: The current iris gain value is retained even if you reset other settings as described in "4.2.1 Resetting Values." For this reason, you will no longer be able to view the default setting. If necessary, make a note of the default setting before adjusting this value.

Options	01	to	99
Description	Minimum gain		Maximum gain

Default: Varies depending on the factory-set value, but corresponds to the value determined with the iris gain adjustment trimmer.



Specifying Remote Iris Gain

Although this value is factory-set, it can be adjusted as needed.

The same remote iris gain value applies to all users, regardless of the current user. Thus, there is no need to switch users in advance. Unlike most other setting adjustments, any changes to this setting also apply to user 0.

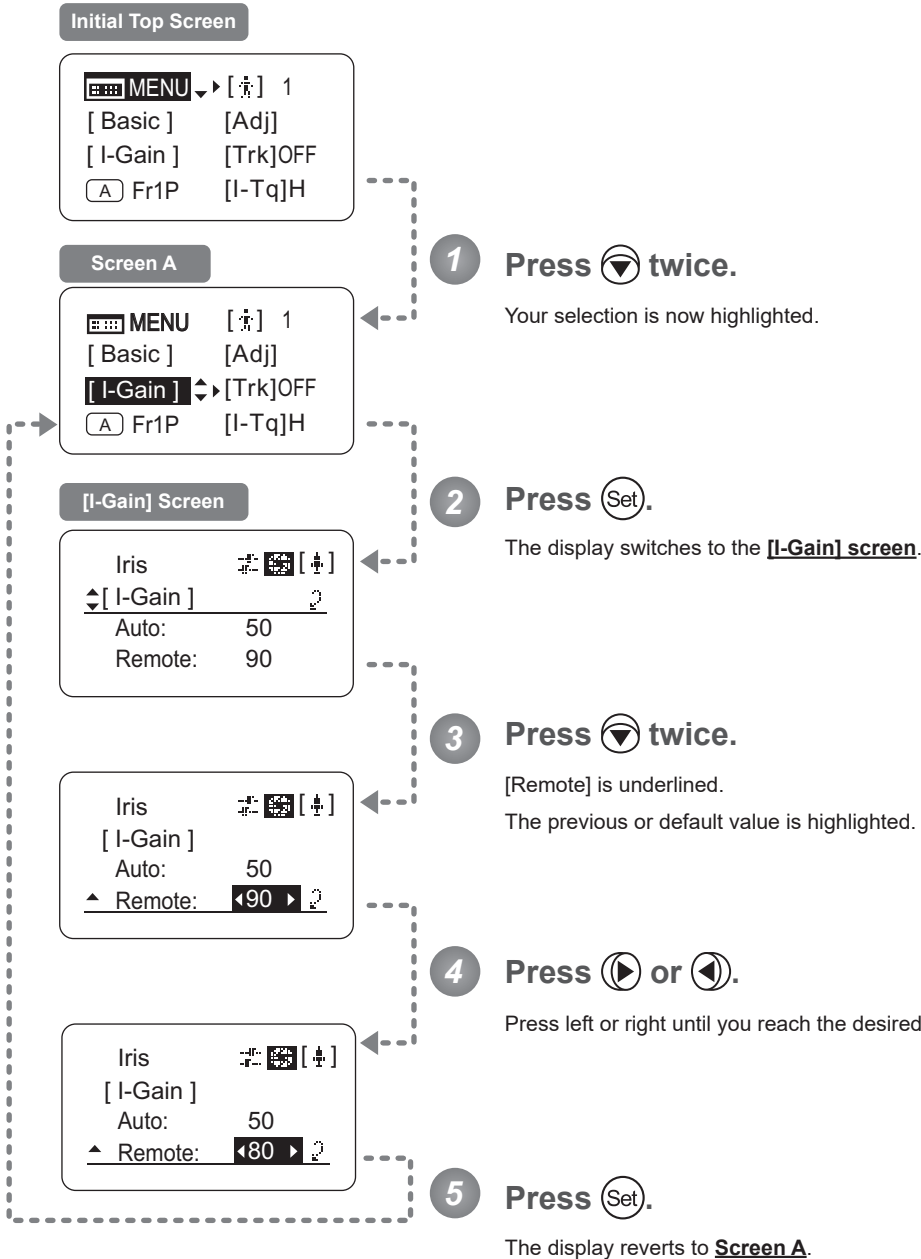

Note: Do the following when adjusting gain while checking iris operation.

- Confirm that the drive unit A/M switch is set to [Auto] mode.
- Set the camera iris mode to [Remote].

Note: The current iris gain value is retained even if you reset other settings as described in "4.2.1 Resetting Values." For this reason, you will no longer be able to view the default setting. If necessary, make a note of the default setting before adjusting this value.

Options	01	to	99
Description	Minimum gain		Maximum gain

Default value: 90



4.1.7 Zoom Tracking ON/OFF

[Trk]

Activate or deactivate zoom tracking as needed.

Important

First, switch to the user for whom the settings apply.

(For instructions, see “4.1.3 Switching Users” or “4.2.1 User Screen Settings: Switching Users.”)

Initial Top Screen

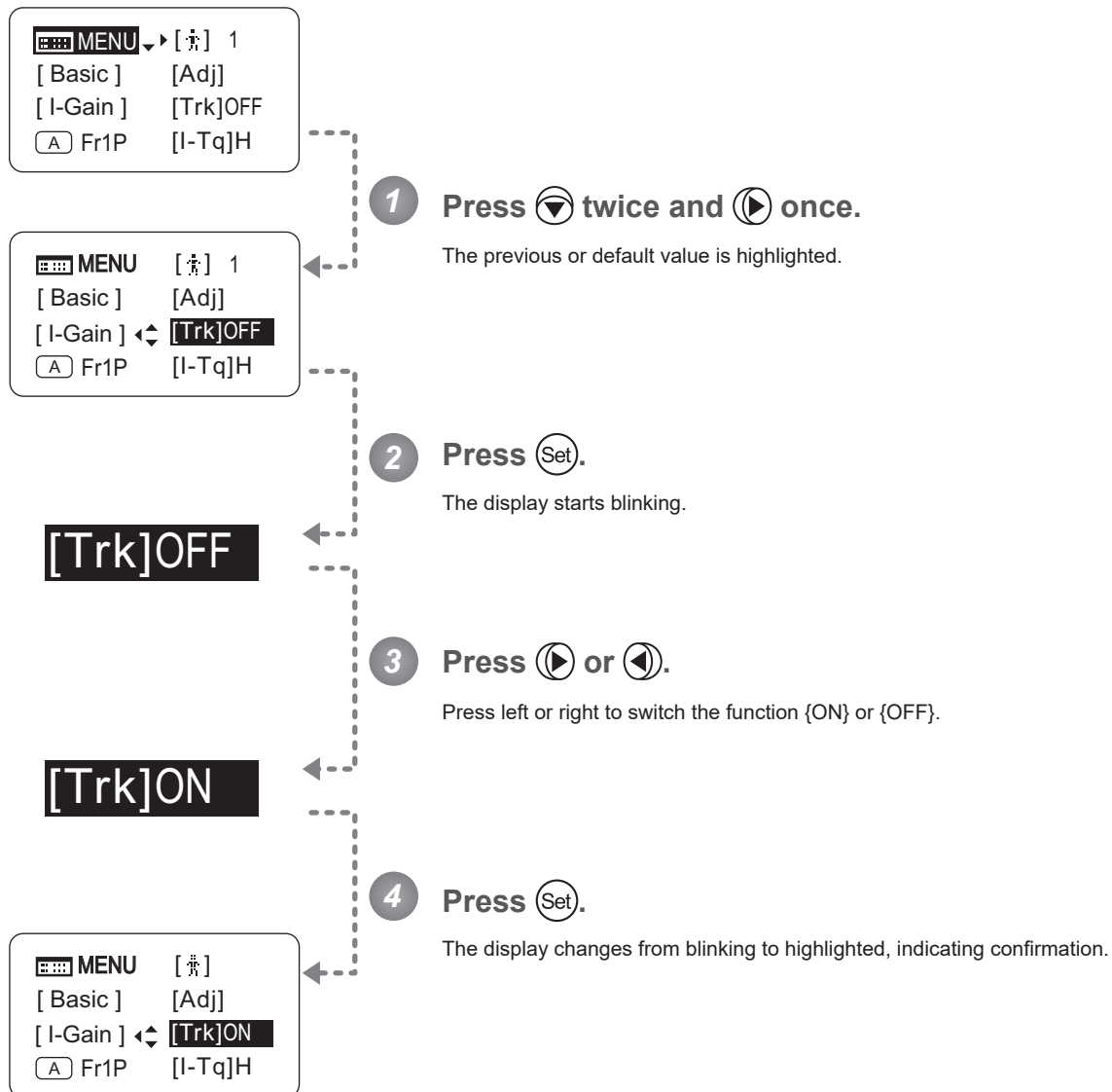

Options	^(D) OFF	ON

(D): Default value



4.1.8 Assigning Functions to the AUX Switch

A

Assign your desired functions to the AUX switch.

Important

First, switch to the user for whom the settings apply.

(For instructions, see “4.1.3 Switching Users” or “4.2.1 User Screen Settings: Switching Users.”)

Initial Top Screen

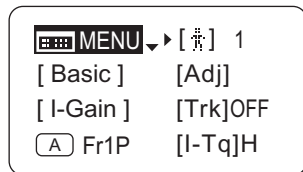

1 Press three times.

The previous or default function is highlighted.

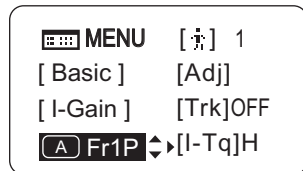

2 Press .

The display starts blinking.



3 Press or .

Press left or right until you reach the desired function.



4 Press .

The display changes from blinking to highlighted, indicating confirmation.

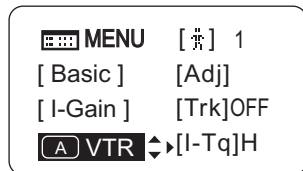

Options	^(D) Fr1P	Fr1F	Fr2P	Fr2F	Sped	Shtl	NON	VTR	RET
Description	Framing Preset1 switch (preset speed)	Framing Preset1 switch (max. speed)	Framing Preset2 switch (preset speed)	Framing Preset2 switch (max. speed)	Speed Preset switch	Shuttle-Shot switch	No function	VTR switch	RET switch

(D): Default value



4.1.9 Specifying Iris Torque

[I-Tq]

Specify the desired level of torque in manual control of the iris ring.

Important

First, switch to the user for whom the settings apply.
(For instructions, see “4.1.3 Switching Users” or “4.2.1 User Screen Settings: Switching Users.”)

Initial Top Screen

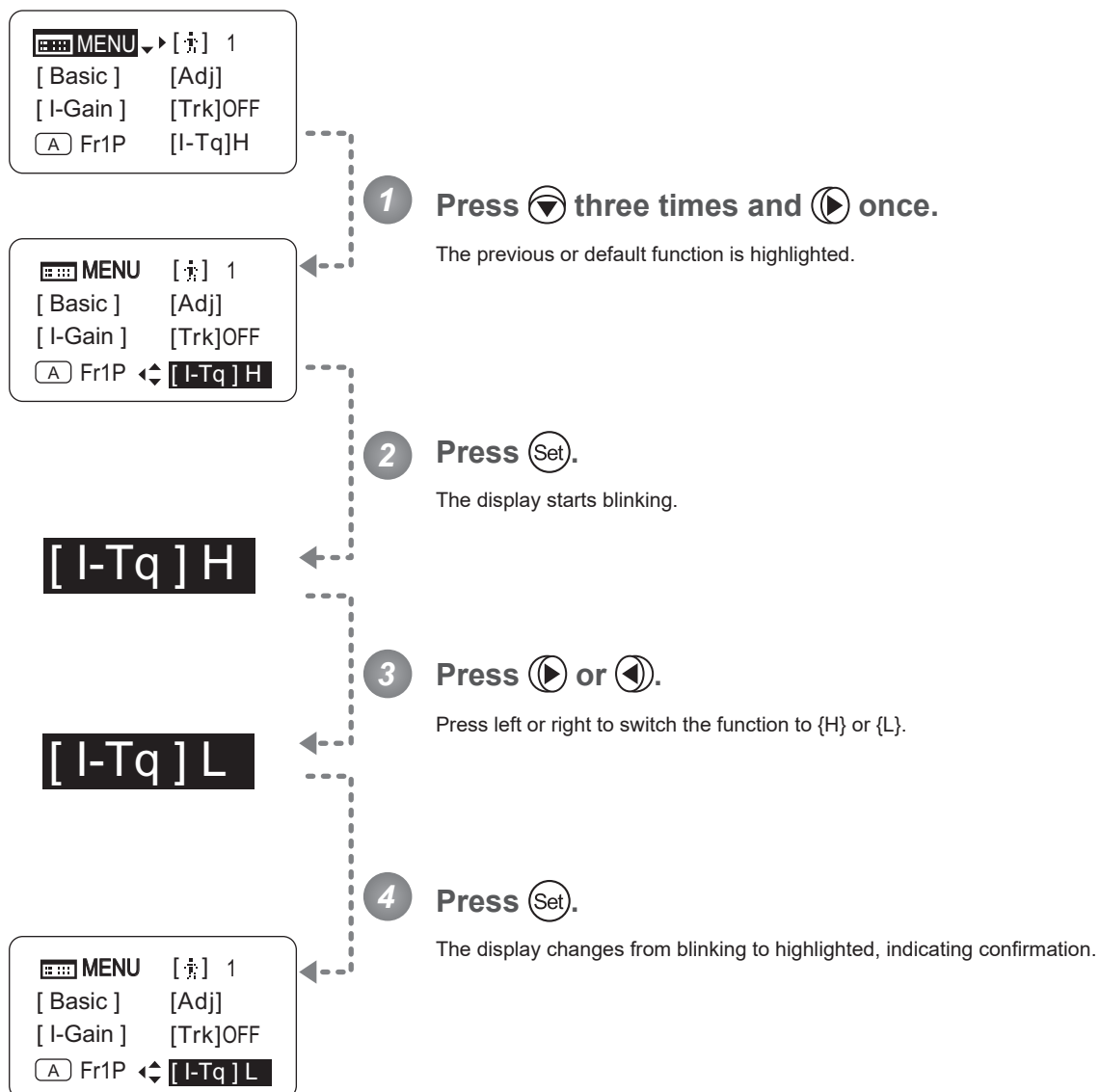

Options	^(D) H	L
Description	High torque	Low torque

(D): Default value

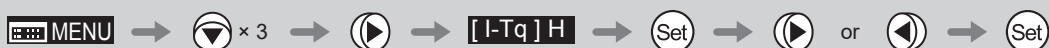

4.1.10 Assigning Functions to the AUX1 Switch

A1

Assign your desired functions to the AUX1 switch.

Important

First, switch to the user for whom the settings apply.

(For instructions, see “4.1.3 Switching Users” or “4.2.1 User Screen Settings: Switching Users.”)

Initial Top Screen

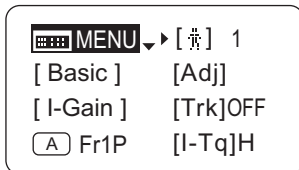

1 Press four times.

The previous or default function is highlighted.

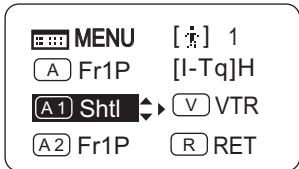

2 Press .

The display starts blinking.



3 Press or .

Press left or right until you reach the desired function.



4 Press .

The display changes from blinking to highlighted, indicating confirmation.

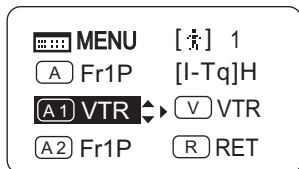

Options	Fr1P	Fr1F	Fr2P	Fr2F	Sped	^(D) Shtl	NON	VTR	RET
Description	Framing Preset1 switch (preset speed)	Framing Preset1 switch (max. speed)	Framing Preset2 switch (preset speed)	Framing Preset2 switch (max. speed)	Speed Preset switch	Shuttle-Shot switch	No function	VTR switch	RET switch

(D): Default value



4.1.11 Assigning Functions to the VTR Switch



Assign your desired functions to the VTR switch.

Important

First, switch to the user for whom the settings apply.

(For instructions, see “4.1.3 Switching Users” or “4.2.1 User Screen Settings: Switching Users.”)

Initial Top Screen

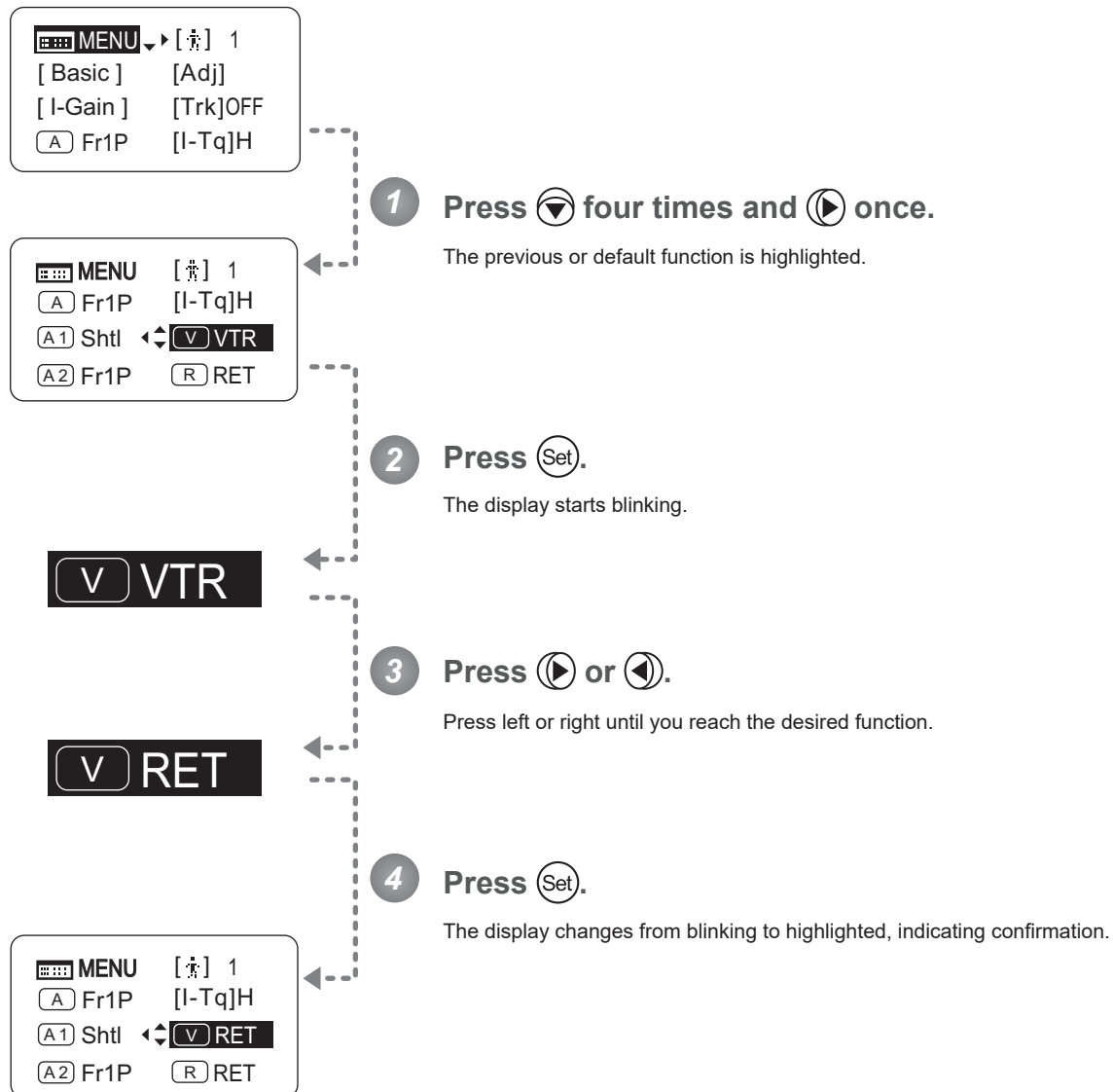

Options	^(D) VTR	RET	Fr1P	Fr1F	Fr2P	Fr2F	Sped	Shtl
Description	VTR switch	RET switch	Framing Preset1 switch (preset speed)	Framing Preset1 switch (max. speed)	Framing Preset2 switch (preset speed)	Framing Preset2 switch (max. speed)	Speed Preset switch	Shuttle-Shot switch

(D): Default value



4.1.12 Assigning Functions to the AUX2 Switch

A2

Assign your desired functions to the AUX2 switch.

Important

First, switch to the user for whom the settings apply.

(For instructions, see “4.1.3 Switching Users” or “4.2.1 User Screen Settings: Switching Users.”)

Initial Top Screen

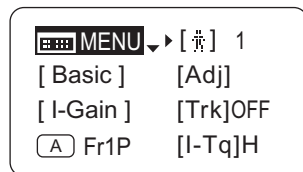

1 Press five times.

The previous or default function is highlighted.

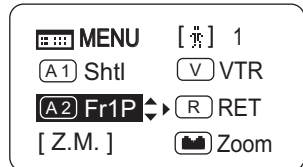

2 Press .

The display starts blinking.



3 Press or .

Press left or right until you reach the desired function.



4 Press .

The display changes from blinking to highlighted, indicating confirmation.

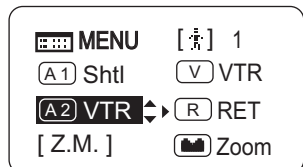

Options	^(D) Fr1P	Fr1F	Fr2P	Fr2F	Sped	Shtl	NON	VTR	RET
Description	Framing Preset1 switch (preset speed)	Framing Preset1 switch (max. speed)	Framing Preset2 switch (preset speed)	Framing Preset2 switch (max. speed)	Speed Preset switch	Shuttle-Shot switch	No function	VTR switch	RET switch

(D): Default value



4.1.13 Assigning Functions to the RET Switch

Assign your desired functions to the RET switch.

Important

First, switch to the user for whom the settings apply.
(For instructions, see “4.1.3 Switching Users” or “4.2.1 User Screen Settings: Switching Users.”)

Initial Top Screen

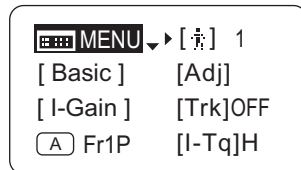

1 Press five times and once.

The previous or default function is highlighted.

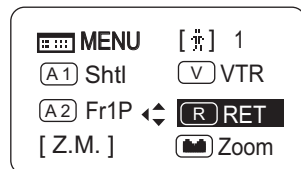

2 Press .

The display starts blinking.



3 Press or .

Press left or right until you reach the desired function.



4 Press .

The display changes from blinking to highlighted, indicating confirmation.

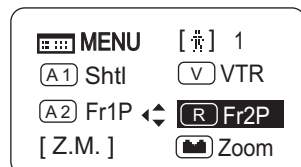

Options	VTR	^(D) RET	Fr1P	Fr1F	Fr2P	Fr2F	Sped	Shtl
Description	VTR switch	RET switch	Framing Preset1 switch (preset speed)	Framing Preset1 switch (max. speed)	Framing Preset2 switch (preset speed)	Framing Preset2 switch (max. speed)	Speed Preset switch	Shuttle-Shot switch

(D): Default value



4.1.14 Specifying Zoom Curve Mode

[Z.M.]

Specifying Seesaw Switch Responsiveness

Configure the responsiveness of zoom speed adjustment in response to pressing the zoom seesaw switch.

(Note: Another screen is displayed when this setting is configured.)

Important

First, switch to the user for whom the settings apply.

(For instructions, see “4.1.3 Switching Users” or “4.2.1 User Screen Settings: Switching Users.”)

Initial Top Screen

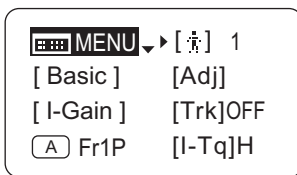

Screen A

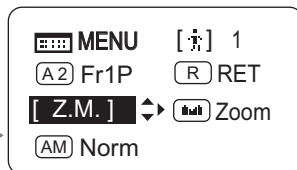

CurveMode Screen

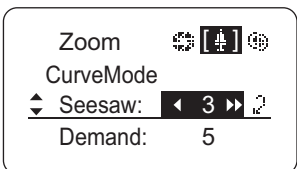
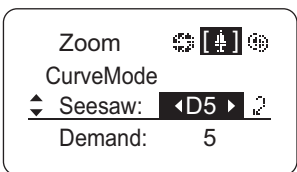
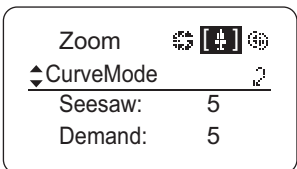

1 Press seven times.

Your selection is now highlighted.

2 Press .

The display switches to the **CurveMode screen**.

3 Press .

[Seesaw] is underlined.
The previous or default value is highlighted.

4 Press or .

Press left or right until you reach the desired value.

5 Press .

The display reverts to **Screen A**.

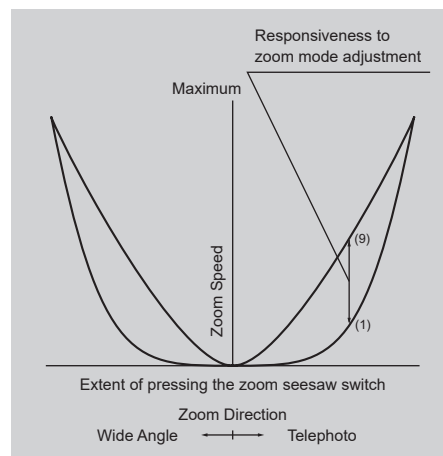

Options	1	2	3	4	(D) 5	6	7	8	9
---------	---	---	---	---	-------	---	---	---	---

(D): Default value



Specifying Analog Demand Responsiveness

Configure the responsiveness of zoom speed adjustment in response to pressing the analog demand thumb ring.
 (Note: Another screen is displayed when this setting is configured.)

Important

First, switch to the user for whom the settings apply.
 (For instructions, see “4.1.3 Switching Users” or “4.2.1 User Screen Settings: Switching Users.”)

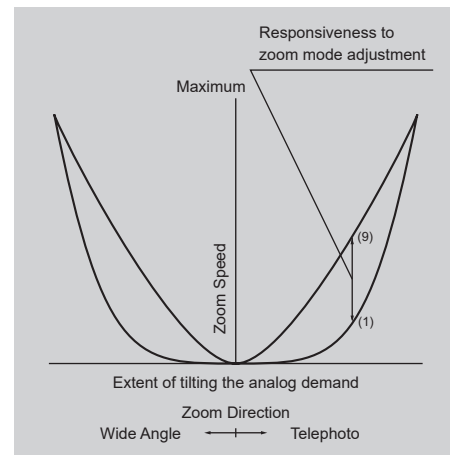
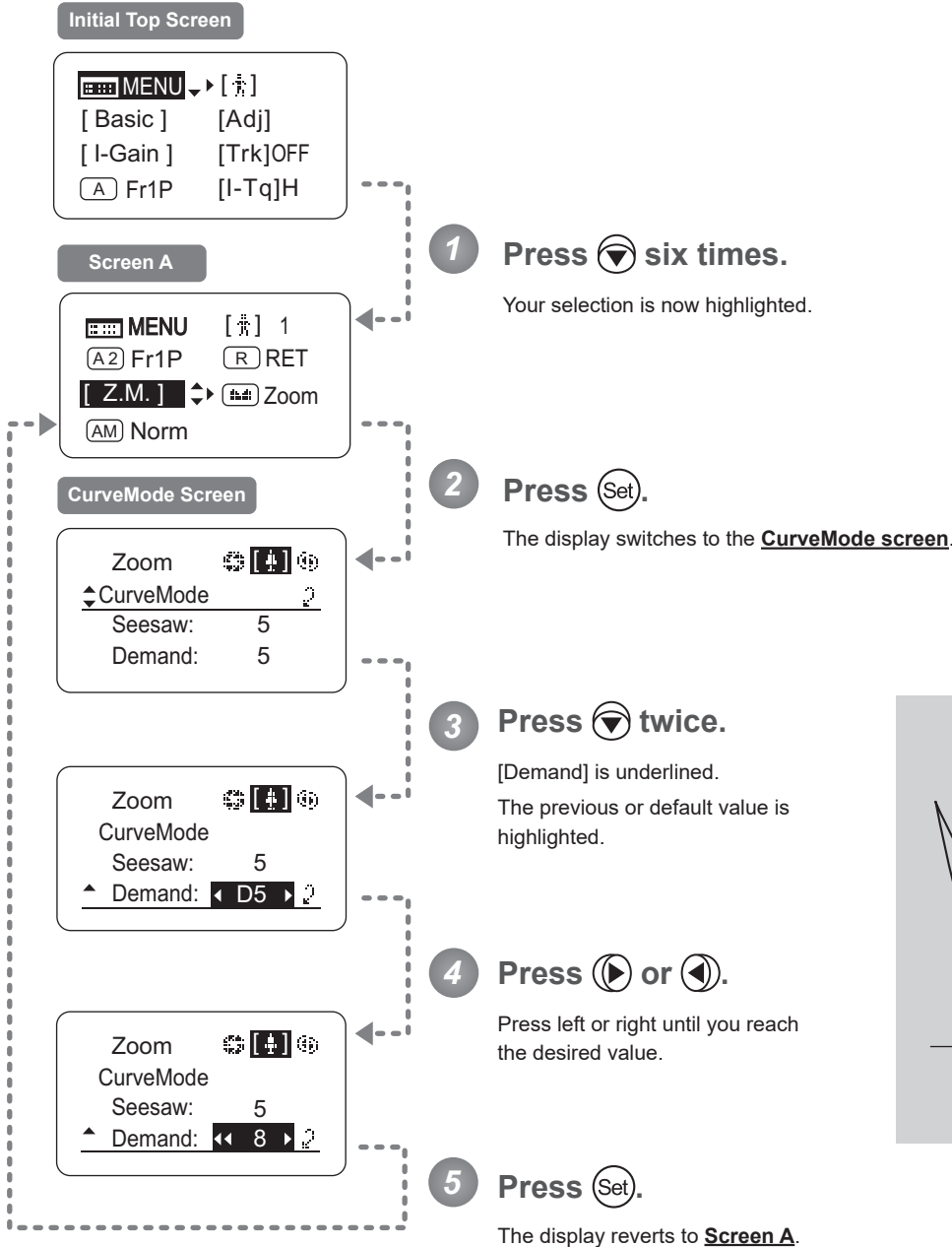

Options	1	2	3	4	(D) 5	6	7	8	9
---------	---	---	---	---	-------	---	---	---	---

(D): Default value



4.1.15 Assigning Functions to the Seesaw



The zoom seesaw switch can be programmed to control either the {Zoom} or {Iris}.

Important

First, switch to the user for whom the settings apply.
(For instructions, see “4.1.3 Switching Users” or “4.2.1 User Screen Settings: Switching Users.”)

Initial Top Screen

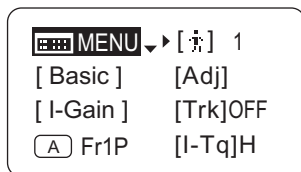

1 Press six times and once.

The previous or default function is highlighted.

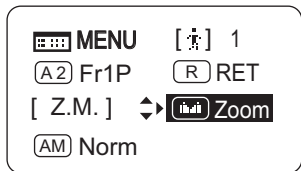

2 Press .

The display starts blinking.



3 Press or .

Press left or right to switch the function to {Zoom} or {Iris}.



4 Press .

The display changes from blinking to highlighted, indicating confirmation.

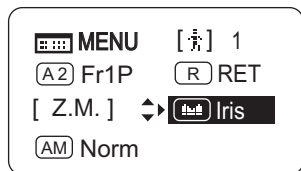

Note: Note on Iris Assignment

1. The seesaw switch will no longer control zooming.
2. To control the iris with the rocker switch, you must set the iris mode to manual.
3. Press the Telephoto side to open the iris, or press the Wide end side to close it.
4. Zoom speed control adjustments also apply to iris control, and you can specify the maximum iris speed. (See “4.2.5 Zoom Screen Settings: Specifying Maximum Zoom Speed Control.”)

Options	^(D) Zoom	Iris
Description	Zoom operation	Iris operation

(D): Default value



4.1.16 Specifying Iris A/M Switch

The iris A/M switch on the top of the drive unit can be programmed to activate a function of your choice.

Important

First, switch to the user for whom the settings apply.

(For instructions, see “4.1.3 Switching Users” or “4.2.1 User Screen Settings: Switching Users.”)

Initial Top Screen

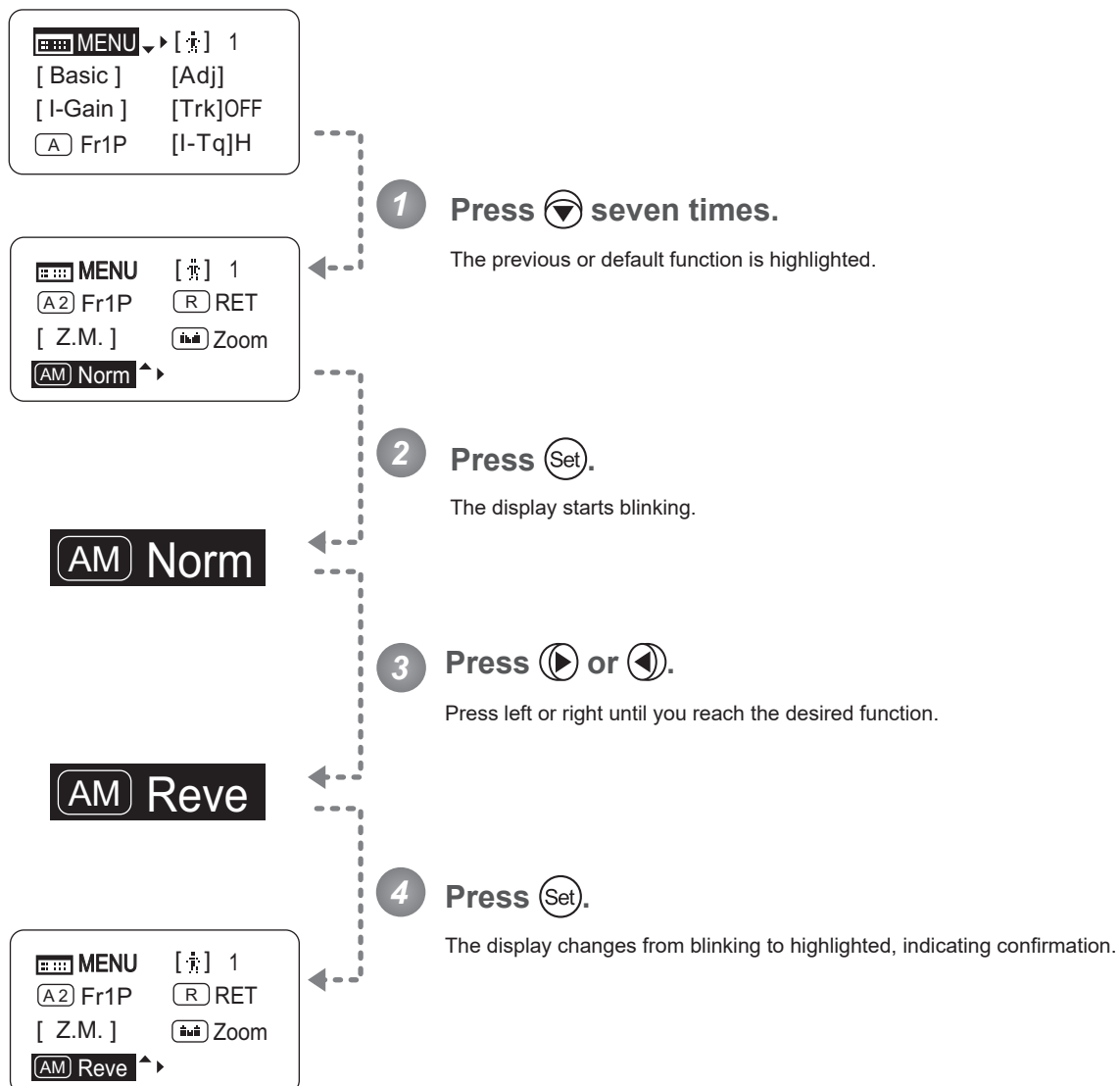

Options	^(D) Norm	Reve	Auto	Manu
Description	Normal operation A : Auto / M : Manual	Reverse operation A : Manual / M : Auto	Auto only A : Auto / M : Auto	Manual only A : Manual / M : Manual

(D): Default value



4.1.17 Escape Operation

Instantly jump to user 0, with default settings, from the current user (0–9).

Note

1. Not available when settings are locked.
2. The following settings remain the same even after jumping to user 0.
Auto and remote iris gain values, encoder output setting, and camera follow voltage adjustments

1 Hold down both the Display switch and **(Set)** for at least 2 seconds.

One of the following messages is displayed, depending on the current user before the operation.

User 0 : User 0 Reset Now
User 1–9 : Escape To User 0

Desired Screen

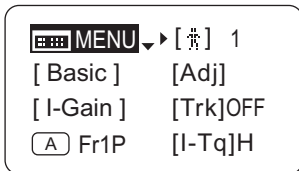

From User 0

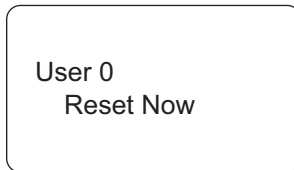

From Users 1–9

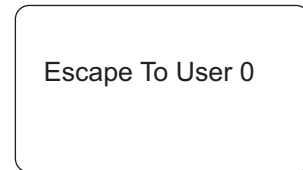

or

Initial Top Screen

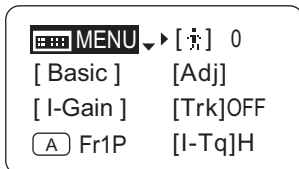

2 The Initial Top screen is displayed.

Note: Initial User When Restarted

After restarting, control reverts to the user before this operation.

However, if you switched users after this operation, control reverts to that user.

[**(DISPLAY)** and **(Set)**] 2 seconds

4.2 Configuration from the Menu Screen

In Full mode, you can view and configure 38 setting items and a “follow” screen with three setting items that have relative values from the **Menu screen**.*

Specifically, the **Menu screen** in Full mode is organized into 8 screens by function: **User screen**, **Switch screen**, **Preset screen**, **Iris screen**, **Zoom screen**, **Focus screen**, **Info screen**, and **Fol. screen**.

Select [MENU] on the **Top screen** and press the Set key to access the **User screen** initially. Press left or right to access the 7 other screens. (See the following figure.)

*: There is no single **Menu screen**. Instead, these 8 screens are collectively referred to as the **Menu screen**.

Setting items labeled **Top** next to the function title can also be configured from the **Top screen**.

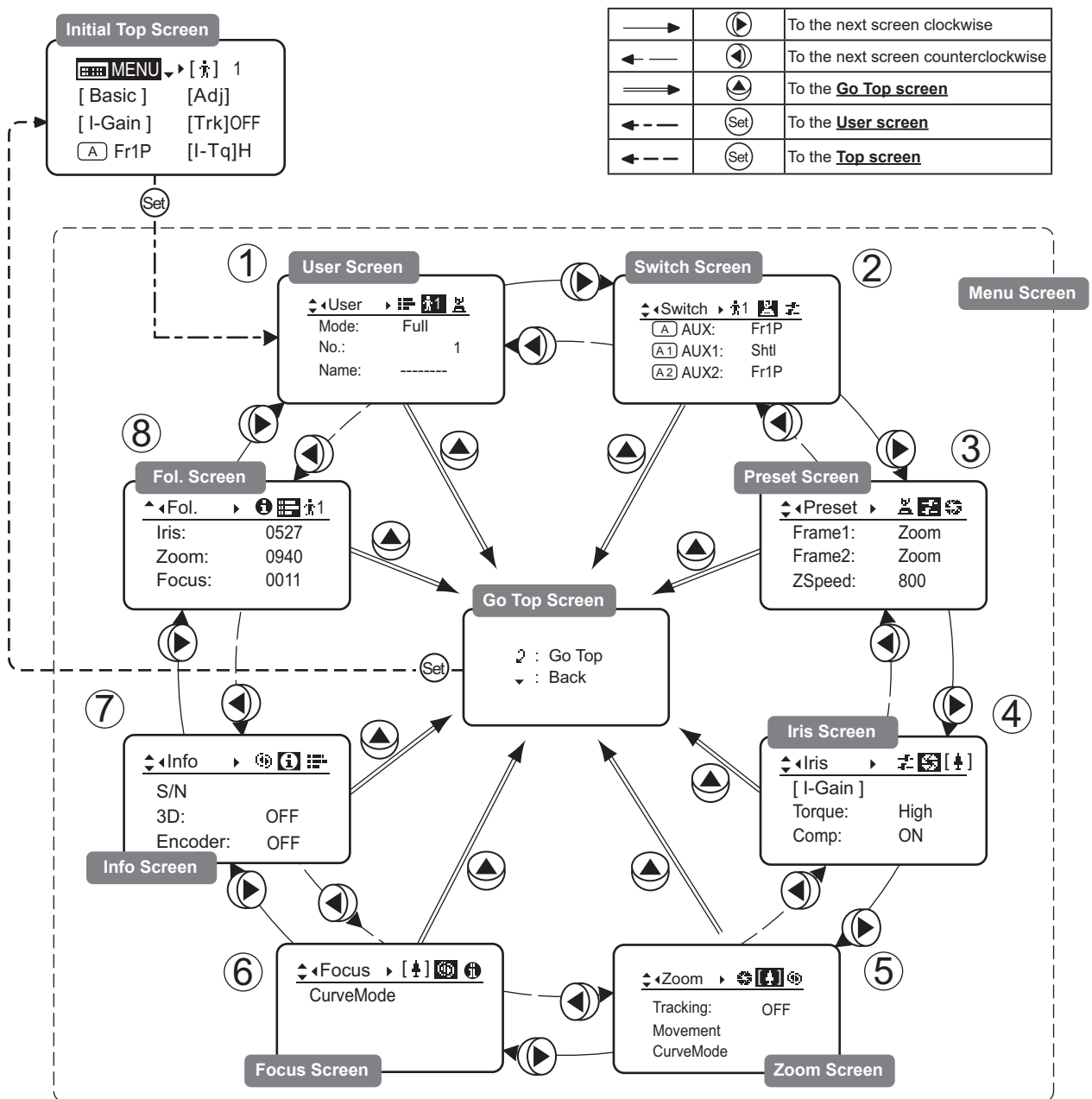

①	User Screen.....	4.2.1
②	Switch Screen.....	4.2.2
③	Preset Screen.....	4.2.3
④	Iris Screen	4.2.4
⑤	Zoom Screen	4.2.5
⑥	Focus Screen	4.2.6
⑦	Info Screen	4.2.7
⑧	Fol. Screen	4.2.8

4.2.1 User Screen Settings

For details on users available in Full mode, see “4.1.3 Switching Users.”

The following setting items can be configured on the User screen.

Switching Modes

Switching Users **Top**

Naming Users

Resetting Values

- (1) Resetting One User’s Settings
- (2) Resetting All Users’ Settings

Copying Settings Between Individual Users

Copying Settings Between Lenses

- (1) Copying One User’s Settings to Another Lens
- (2) Copying All Users’ Settings to Another Lens
- (3) Responding to Errors

Locking Functions

Items labeled **Top** can also be modified from the Top screen.

User Screen in Full Mode

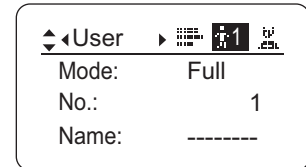

Switching Modes

Switch to Basic or Analog mode as needed.

Important

The new mode setting is retained even after the lens is turned off.

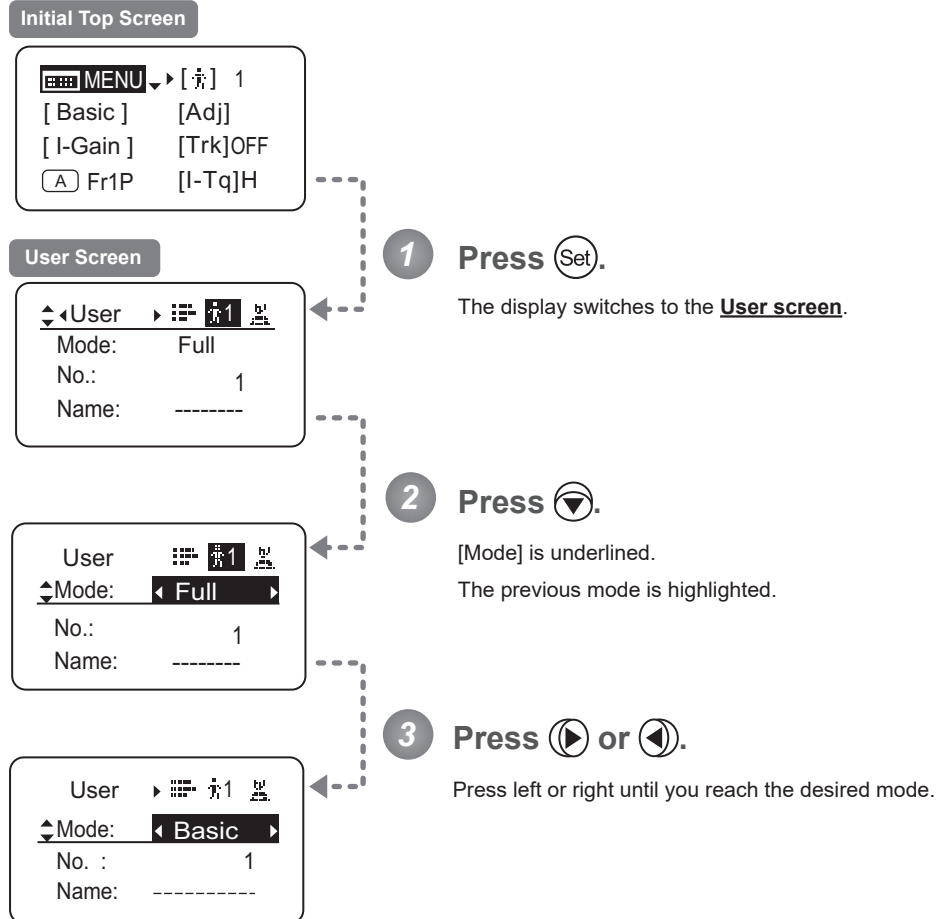

Options	^(D) Basic	Full	Analog
Save Settings	Basic Mode	Full Mode	Analog Mode

(D): Default value



Switching Users Top

Switch Users (0–9) as needed. To configure settings for individual users, switch to that user number.

Initial Top Screen

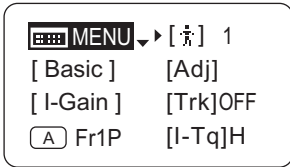

User Screen

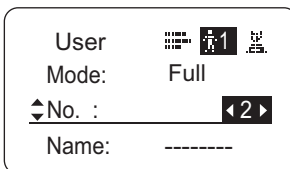
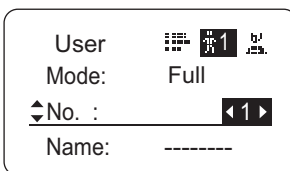
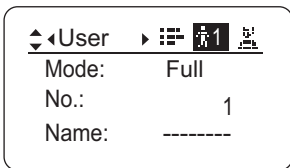

1 Press .

The display switches to the **User screen**.

2 Press twice.

[No.] is underlined.

The previous or default value is highlighted.

3 Press or .

Press left or right until you reach the desired mode.

Options	0	^(D) 1	2	3	4	5	6	7	8	9
Save Settings	Not supported Although settings cannot be saved, they can be changed temporarily. Switching users or turning the lens off will restore default values.	Can be saved for each user								

(D): Default value



Naming Users

Users can be named, as needed.

Initial Top Screen

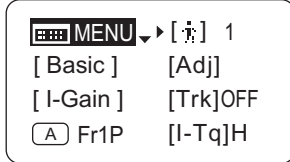

User Screen

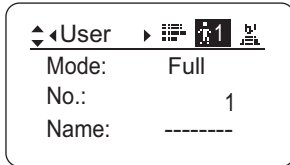

Title: Name

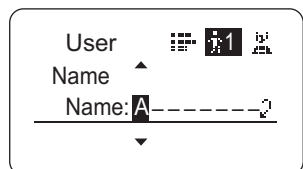
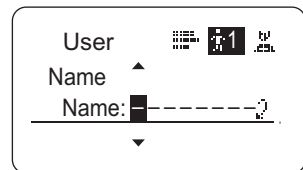
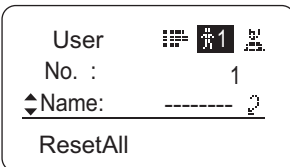

Title: Name

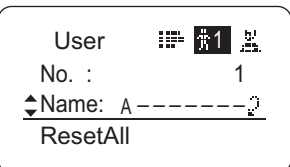

1 Press **Set**.

The display switches to the **User screen**.

2 Press **Down Arrow** three times.

[Name] is underlined.

3 Press **Set**.

The first dash is highlighted, indicating that you can edit it.

4 Enter the name.

Entering Name

Press up/down to find characters and left/right to move the cursor or make corrections.

5 Press the **Set** to confirm the name.

The display reverts to **Title: Name**.

Important

First, switch to the user for whom the settings apply.
(For instructions, see "4.1.3 Switching Users" or "4.2.1 User Screen Settings: Switching Users.")

Options	_(D) - ABCDEFGHIJKLMNOPQRSTUVWXYZabcdefghijklmnopqrstuvwxyz0123456789
Max. Digits	8

(D) : Default value

_ : Space



Resetting Values

(1) Resetting One User's Settings

Reset a user's settings to default values as needed.

Initial Top Screen

```

MENU [ ] 1
[ Basic ] [Adj]
[ I-Gain ] [Trk]OFF
[A] Fr1P [I-Tq]H
            
```

User Screen

```

User 1
Mode: Full
No.: 1
Name: -----
            
```

Title: Reset

```

User 1
Name: -----
ResetAll 2
Copy
            
```

Reset Screen

```

User 1
ResetAll 2
User: y/n
AllUser: y/n
            
```

```

User 1
ResetAll
User: y/n
AllUser: y/n
            
```

User 1
Reset Now.







Title: Reset

```

User 1
Name: -----
ResetAll 2
Copy
            
```

Important

First, switch to the user for whom the settings apply.
(For instructions, see "4.1.3 Switching Users" or "4.2.1 User Screen Settings: Switching Users.")

- 1 Press .**
The display switches to the **User screen**.
- 2 Press  four times.**
[ResetAll] is underlined.
- 3 Press .**
The display switches to the **Reset screen**.
- 4 Press .**
A confirmation message is displayed about resetting information for the selected user.
- 5 Press  and then .**
After a message is displayed indicating that resetting is in progress, the display reverts to **Title: Reset**.
The settings have now been reset.

Note: Iris gain values, encoder output setting, and camera follow voltage adjustments are not reset. The current value is retained.

Note: You can cancel resetting and restore the original values at any time before pressing  in step 5. To return to the previous screen, press up. To cancel resetting and turn off the display, press the Display switch.



(2) Resetting All Users' Settings

Reset all users' settings to default values as needed.

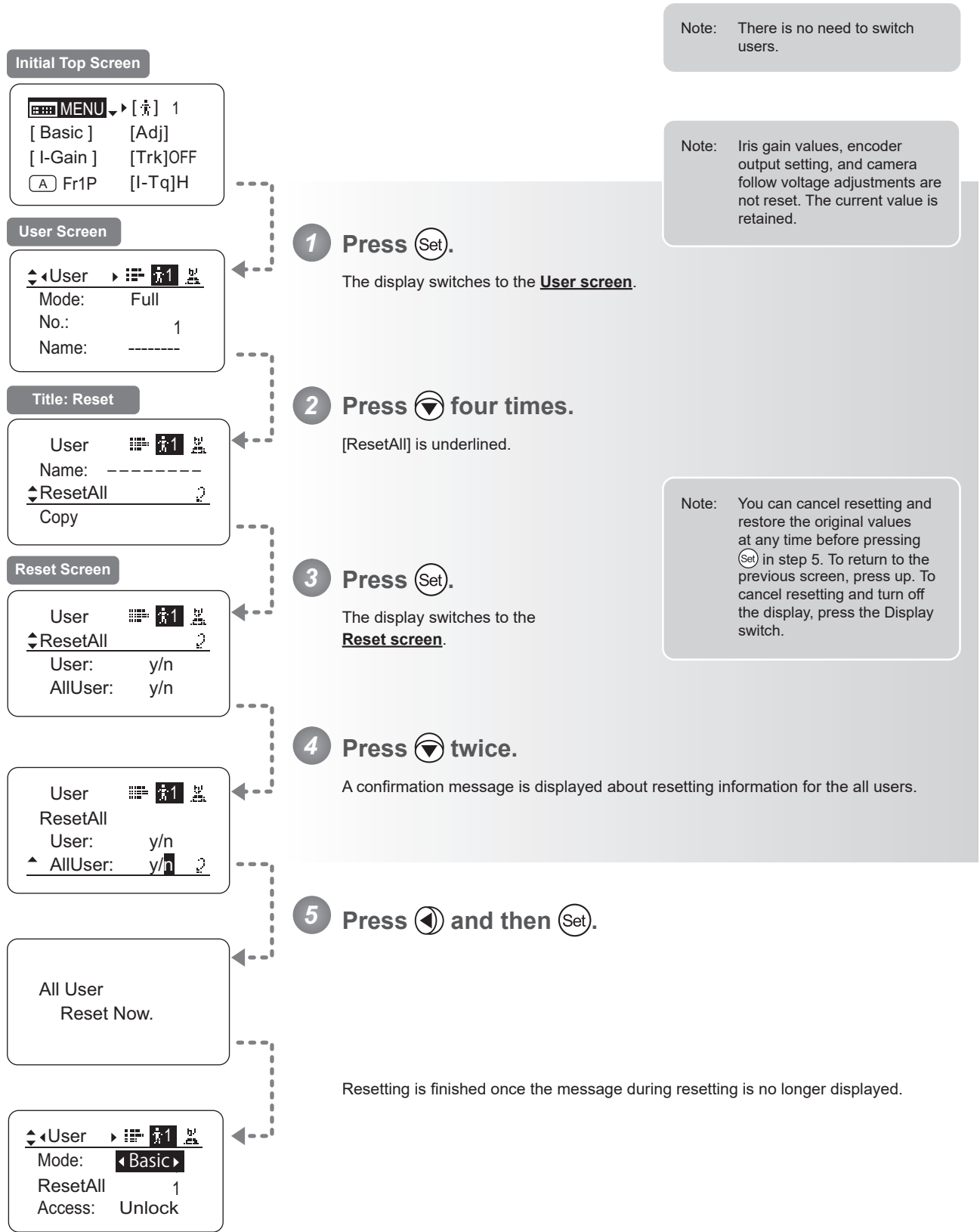

Copying Settings Between Individual Users

Settings configured for one user can be copied to another user.

Important

First, switch to the user for whom the settings apply.
(For instructions, see “4.1.3 Switching Users” or “4.2.1 User Screen Settings: Switching Users.”)

Initial Top Screen

```

MENU [ ] 1
[ Basic ] [Adj]
[ I-Gain ] [Trk]OFF
(A) Fr1P [I-Tq]H
            
```

User Screen

```

User
Mode: Full
No.: 1
Name: -----
            
```

Screen A

```

User
ResetAll
Copy
ToOtherLens
            
```

Copy Screen

```

User
Copy
To No. : 1
Copy: y/n
            
```

```

User
Copy
To No. : <1>
Copy: y/n
            
```

```

User
Copy
To No. : <3>
Copy: y/n
            
```

```

User
Copy
To No. : 3
Copy: y/n
            
```

- 1 Press .**
The display switches to the User screen.
- 2 Press five times.**
[Copy] is underlined.
- 3 Press .**
The display switches to the Copy screen.
- 4 Press .**
[To No.] is underlined.
- 5 Press or .**
Press left or right until you reach the user to copy settings to.
- 6 Press .**
[Copy] is underlined, and you can select {y} (yes) or {n} (no).

Note: You can cancel copying and restore the original values at any time before pressing in step 7. To return to the previous screen, press up. To cancel copying and turn off the display, press the Display switch.

Continued from previous page

Screen A

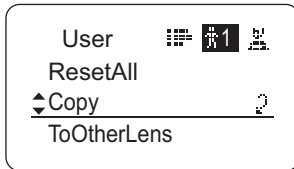

7 Press and then .

Settings are copied to the specified user number, and the display reverts to **Screen A**.

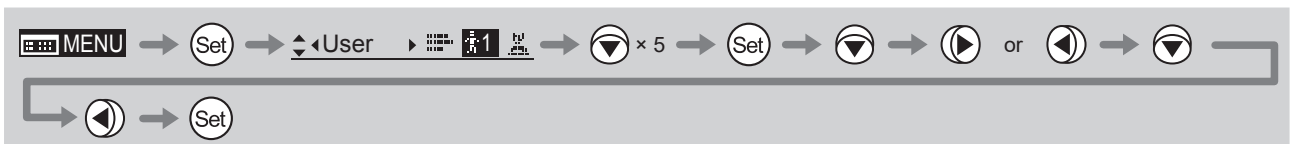

Copying Settings Between Lenses

Setting information can be copied between information displays of drive units mounted on the display. You can copy either settings for individual users or for all users. Copying requires a dedicated cable, sold separately. For details, contact Canon or your dealer.

(1) Copying One User's Settings to Another Lens

Initial Top Screen

```

MENU [ 1
[ Basic ] [Adj]
[ I-Gain ] [Trk]OFF
[A] Fr1P [I-Tq]H
            
```

User Screen

```

User
Mode: Full
No.: 1
Name: -----
            
```

Screen A

```

User
Copy
ToOtherLens
Access: Unlock
            
```

ToOtherLens Screen

```

User
ToOtherLens
Connect: y/n
            
```

Screen B

```

User
ToOtherLens
UserCopy : y/n
AllCopy : y/n
            
```

Note: Required Preparation

1. Plug one end of the dedicated cable (20 pin–20 pin) into the source lens and the other end into the 20-pin connector of the zoom/focus remote of the target lens.
2. Turn on the source and target lenses.
3. Press the Display switch on the source lens to turn on the display. (Leave the source lens display off.)

Important

First, switch to the user for whom the settings apply. (For instructions, see “4.1.3 Switching Users” or “4.2.1 User Screen Settings: Switching Users.”)

Note: You can cancel copying and restore the original values at any time before pressing (Set) in step 11. To return to the previous screen, press up. To cancel copying and turn off the display, press the Display switch.

1 Press (Set).
The display switches to the User screen.

2 Press (Down Arrow) six times.
[ToOtherLens] is underlined.

3 Press (Set).
The display switches to the ToOtherLens screen.

4 Press (Down Arrow).
[Connect] is underlined, and you can select {y} (yes) or {n} (no).

5 Press (Left Arrow) and then (Set).
The display switches to Screen B.

6 Press (Down Arrow).

Continued from previous page

Copy Selection Screen

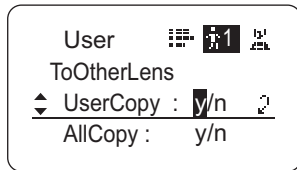

The display switches to the Copy selection screen.

Target User Selection Screen

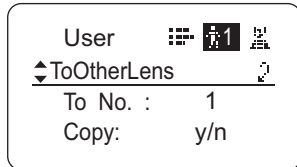

7 Press (Set).

The display switches to the Target user selection screen.

8 Press (Down Arrow).

[To No.] is underlined.

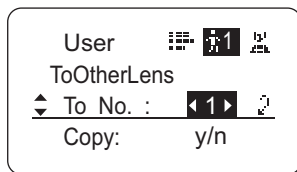

9 Press (Right Arrow) or (Left Arrow).

Press left or right until you reach the number of the user on the target lens to copy settings to.

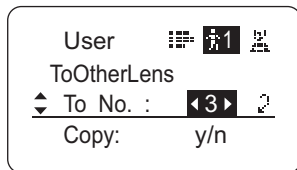

10 Press (Down Arrow).

[Copy] is underlined, and you can select {y} (yes) or {n} (no).

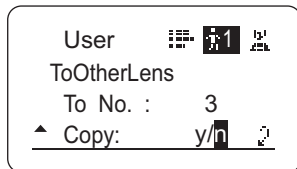

11 Press (Left Arrow) and then (Set). *1

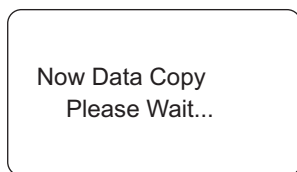

*1: Pressing the Set key in this step begins the copying process. Note that once copying begins, you cannot restore the original settings.

*2: To avoid problems during copying, do not operate controls or press the Display switch on the source or target lenses. Do not perform other operations.

Screen A

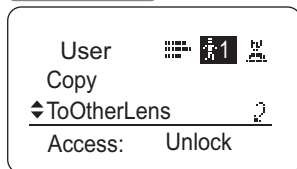

After a message is displayed indicating that copying is in progress, the display reverts to Screen A.

The settings have now been copied between lenses. *2

Note: If copying fails, an error message is displayed. Respond as described in "(3) Responding to Errors."

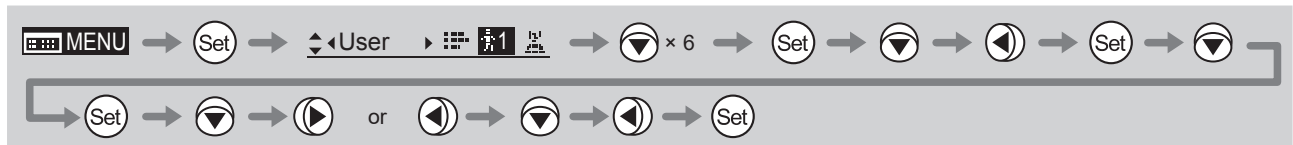

(2) Copying All Users' Settings to Another Lens

Copying requires a dedicated cable, sold separately. For details, contact Canon or your dealer.

Note: Required Preparation

1. Plug one end of the dedicated cable (20 pin–20 pin) into the source lens and the other end into the 20-pin connector of the zoom/focus remote of the target lens.
2. Turn on the source and target lenses.
3. Press the Display switch on the source lens to turn on the display. (Leave the source lens display off.)

Initial Top Screen

```

MENU ▾ ▶ [ 1 ]
[ Basic ] [Adj]
[ I-Gain ] [Trk]OFF
(A) Fr1P [I-Tq]H
    
```

User Screen

```

◀ User ▶ [ 1 ]
Mode: Full
No.: 1
Name: -----
    
```

Screen A

```

User [ 1 ]
Copy
◀ ToOtherLens ▶
Access: Unlock
    
```

ToOtherLens Screen

```

User [ 1 ]
◀ ToOtherLens ▶
Connect: y/n
    
```

```

User [ 1 ]
ToOtherLens
^ Connect: y/n
    
```

1 Press (Set).

The display switches to the User screen.

2 Press (Down Arrow) six times.

[ToOtherLens] is underlined.

3 Press (Set).

The display switches to the ToOtherLens screen.

4 Press (Down Arrow).

[Connect] is underlined, and you can select {y} (yes) or {n} (no).

5 Press (Left Arrow) and then (Set).

Note: You can cancel copying and restore the original values at any time before pressing (Set) in step 9. To return to the previous screen, press up. To cancel copying and turn off the display, press the Display switch.

Continued on next page

Continued from previous page

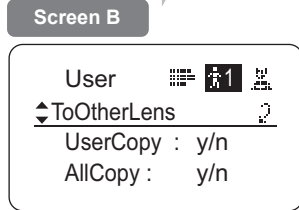

The display switches to **Screen B**.

6 Press twice.

[AllCopy] is underlined, and you can select {y} (yes) or {n} (no).

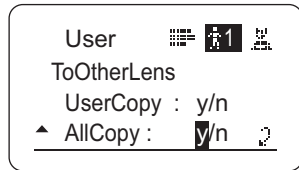

7 Press .

The display switches to the **AllCopy screen**.

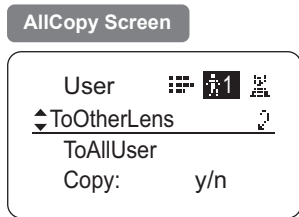

8 Press .

[Copy] is underlined, and you can select {y} (yes) or {n} (no).

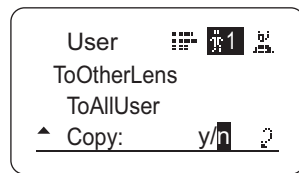

9 Press and then .

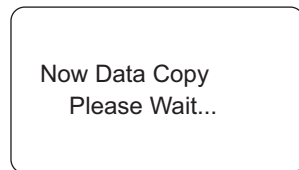

After a message is displayed indicating that copying is in progress, the display reverts to **Screen A**.

The settings have now been copied between lenses. ^{*2}

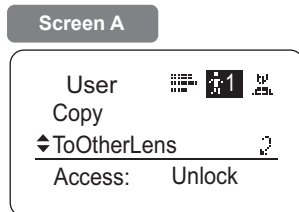

*1: Pressing the Set key in this step begins the copying process. Note that once copying begins, you cannot restore the original settings.

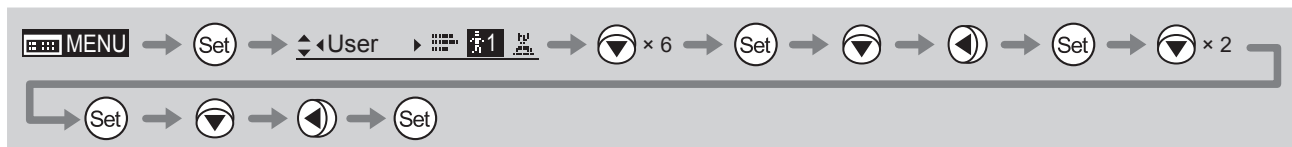

*2: To avoid problems during copying, do not operate controls or press the Display switch on the source or target lenses. Do not perform other operations.

Note: If copying fails, an error message is displayed. Respond as described in "(3) Responding to Errors."

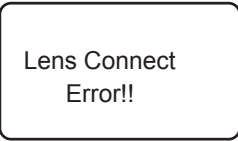

(3) Responding to Errors

If copying between lenses fails, check the following.

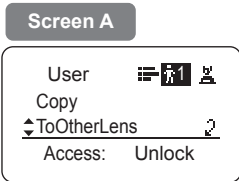
Error Screen	Checking Item	Problem	Responding
	Confirm that the dedicated cable (20 pin–20 pin) is connected.	Settings cannot be copied between lenses unless the cable is connected.	Securely connect the cable between the source and target lenses, and follow the steps to copy again, from the start.
	Confirm that the target lens is on.	Settings cannot be copied unless both the source and target lenses are on.	Turn on both the source and target lenses, and follow the steps to copy again, from the start.
	Confirm that the drive unit of the target lens is the same model.	Settings cannot be copied between lenses of different generations of drive units.	Contact Canon or your dealer for details on models of drive unit that can be used to copy settings.
	Confirm that the dedicated cable (20 pin–20 pin) is connected.	The message at left is displayed if the lenses are disconnected during copying, if a power outage occurs, or if a lens is turned off. In this case, copying is interrupted, which prevents the settings from being copied correctly.	Confirm that the source and target lenses are on, and that the cable is securely connected. Press the Display switch to return to Screen A , and follow the steps to copy again, from the start. 
	Confirm that the source and target lenses are on.		

Lock Functions

To ensure that configured functions cannot easily be changed, you can lock the settings of certain functions. Once functions are locked, they are locked for all users.

For instructions on locking settings in Analog mode, see “5. Operation in Analog Mode.”



Note

- User numbers 0–9 in the user number field indicate users that are unlocked.
“Lock” in the user number field indicate users that are locked.
- In lock mode, only the following items can still be configured, and other settings are locked.
 - Preset data (Shuttle shot position, Frame preset position, Preset speed)
 - Zoom tracking position, on/off
 - Auto iris gain setting
 - Specifying encoder output
 - Camera follow voltage adjustments

(1) Locking Settings

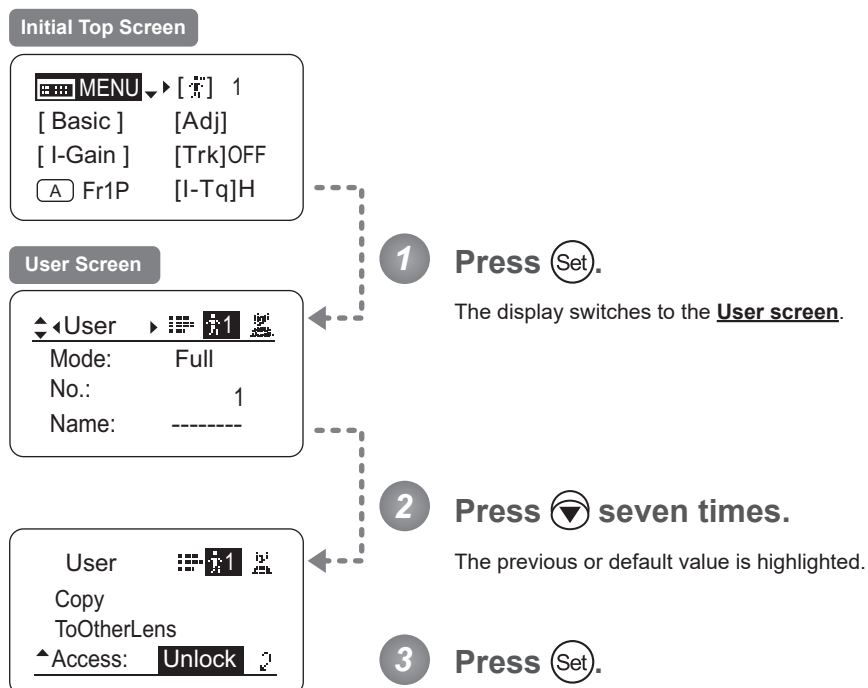

Continued on next page

Continued from previous page

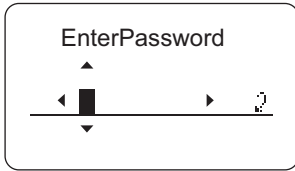

4 Enter the password and press (Set).

Entering Passwords

Press up/down to find characters and left/right to move the cursor or make corrections. Be careful not to press the Set key until you are finished entering the password.

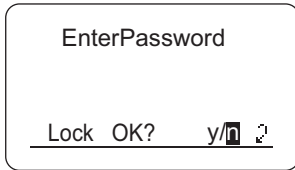

5 Press (Left Arrow) and then (Set).

The settings are now locked.

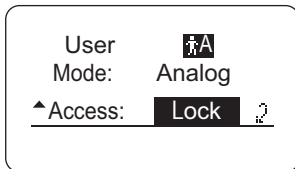

Note

Passwords

No master password is used on this model. The password you enter each time to lock settings is the password used to unlock them. For this reason, we recommend making a note of the password each time. If you forget the password, contact Canon or your dealer. Passwords can be blank or up to 8 digits.

Characters supported in passwords

Options	(D) _-ABCDEFGHIJKLMN OPQRSTUVWXYZabcdefghijklmnopqrstuvwxyz0123456789
Max. Digits	8

(D) : Default value
_ : Space

Options	(D) Unlock	Lock
----------------	------------	------

(D): Default value

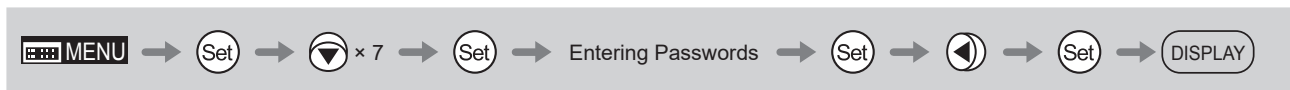

(2) Unlocking Settings

Settings can be unlocked in two ways, as follows.

(Unlocking Setting 1)

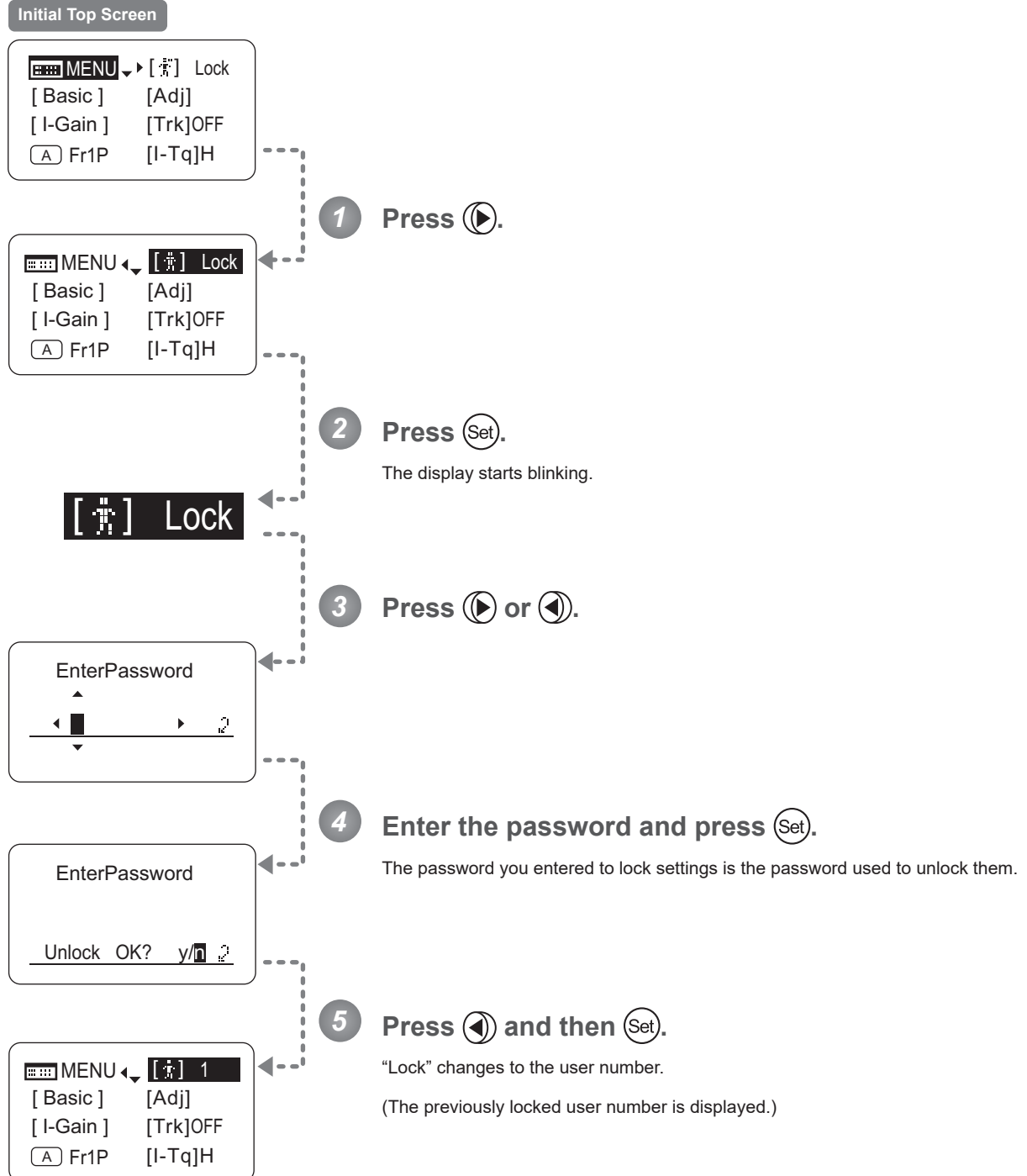

Options	^(D) Unlock	Lock
---------	-----------------------	------

(D): Default value



(Unlocking Setting 2)

Initial Top Screen

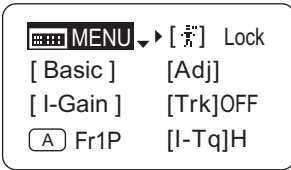

User Screen

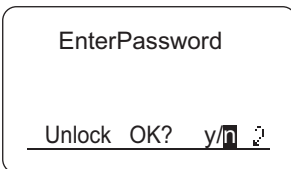
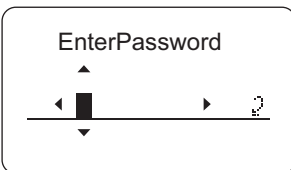
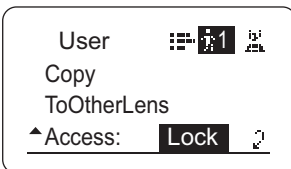
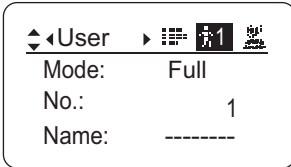

1 Press **Set**.

The display switches to the **User screen**.

2 Press **Down Arrow** seven times.

3 Press **Set**.

4 Enter the password and press **Set**.

The password you entered to lock settings is the password used to unlock them.

5 Press **Left Arrow** and then **Set**.

The settings are now unlocked.



4.2.2 Switch Screen Settings

The following setting items can be configured on the **Switch screen**.

Assigning Functions to the AUX Switch	Top
Assigning Functions to the AUX1 Switch	Top
Assigning Functions to the AUX2 Switch	Top
Assigning Functions to the VTR Switch	Top
Assigning Functions to the RET Switch	Top
Specifying Iris A/M Switch	Top
Assigning Functions to the Seesaw	Top

Items labeled **Top** can also be modified from the **Top screen**.

Assigning Functions to the AUX Switch Top

The AUX switch can be programmed to activate a function of your choice.

Important

First, switch to the user for whom the settings apply.

(For instructions, see “4.1.3 Switching Users” or “4.2.1 User Screen Settings: Switching Users.”)

Initial Top Screen

```

MENU [Basic] [Adj]
[I-Gain] [Trk]OFF
[A] Fr1P [I-Tq]H
    
```

Switch Screen

```

Switch 1
[A] AUX: Fr1P
[A1] AUX1: Shtl
[A2] AUX2: Fr1P
    
```

1 Press **Set** and then **▶**.

The display switches to the **Switch screen**.

2 Press **▼**.

[AUX] is underlined.

The previous or default function is highlighted.

3 Press **▶** or **◀**.

Press left or right until you reach the desired function.

```

Switch 1
[A] AUX: Fr1P
[A1] AUX1: Shtl
[A2] AUX2: Fr1P
    
```

```

Switch 1
[A] AUX: VTR
[A1] AUX1: Shtl
[A2] AUX2: Fr1P
    
```

Options	^(D) Fr1P	Fr1F	Fr2P	Fr2F	Sped	Shtl	NON	VTR	RET
Description	Framing Preset1 switch (preset speed)	Framing Preset1 switch (max. speed)	Framing Preset2 switch (preset speed)	Framing Preset2 switch (max. speed)	Speed Preset switch	Shuttle-Shot switch	No function	VTR switch	RET switch

(D): Default value

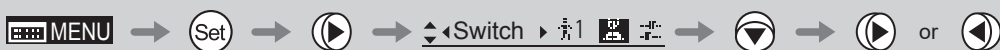

Assigning Functions to the AUX1 Switch Top

The AUX1 switch can be programmed to activate a function of your choice.

Important

First, switch to the user for whom the settings apply.

(For instructions, see “4.1.3 Switching Users” or “4.2.1 User Screen Settings: Switching Users.”)

Initial Top Screen

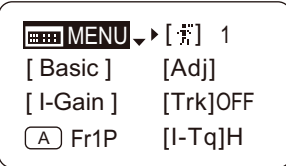

Switch Screen

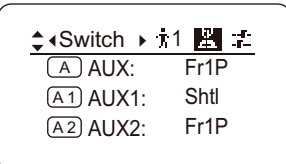

1 Press **Set** and then **▶**.

The display switches to the **Switch screen**.

2 Press **▼** twice.

[AUX1] is underlined.
The previous or default function is highlighted.

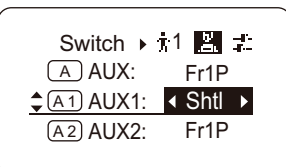

3 Press **▶** or **◀**.

Press left or right until you reach the desired function.

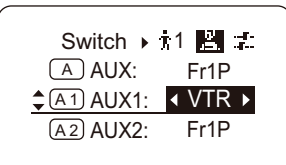

Options	Fr1P	Fr1F	Fr2P	Fr2F	Sped	^(D) Shtl	NON	VTR	RET
Description	Framing Preset1 switch (preset speed)	Framing Preset1 switch (max. speed)	Framing Preset2 switch (preset speed)	Framing Preset2 switch (max. speed)	Speed Preset switch	Shuttle-Shot switch	No function	VTR switch	RET switch

(D): Default value



Assigning Functions to the AUX2 Switch Top

The AUX2 switch can be programmed to activate a function of your choice.

Important

First, switch to the user for whom the settings apply.

(For instructions, see “4.1.3 Switching Users” or “4.2.1 User Screen Settings: Switching Users.”)

Initial Top Screen

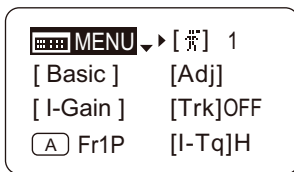

Switch Screen

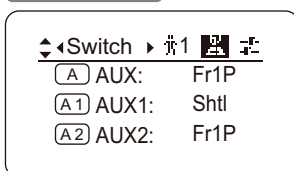

1 Press and then .

The display switches to the **Switch screen**.

2 Press three times.

[AUX2] is underlined.

The previous or default function is highlighted.

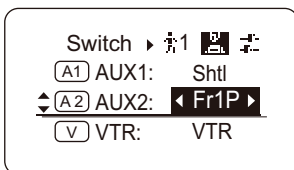

3 Press or .

Press left or right until you reach the desired function.

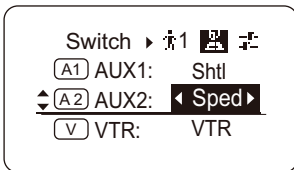

Options	^(D) Fr1P	Fr1F	Fr2P	Fr2F	Sped	Shtl	NON	VTR	RET
Description	Framing Preset1 switch (preset speed)	Framing Preset1 switch (max. speed)	Framing Preset2 switch (preset speed)	Framing Preset2 switch (max. speed)	Speed Preset switch	Shuttle-Shot switch	No function	VTR switch	RET switch

(D): Default value



Assigning Functions to the VTR Switch Top

The VTR switch can be programmed to activate a function of your choice.

Important

First, switch to the user for whom the settings apply.
 (For instructions, see “4.1.3 Switching Users” or “4.2.1 User Screen Settings: Switching Users.”)

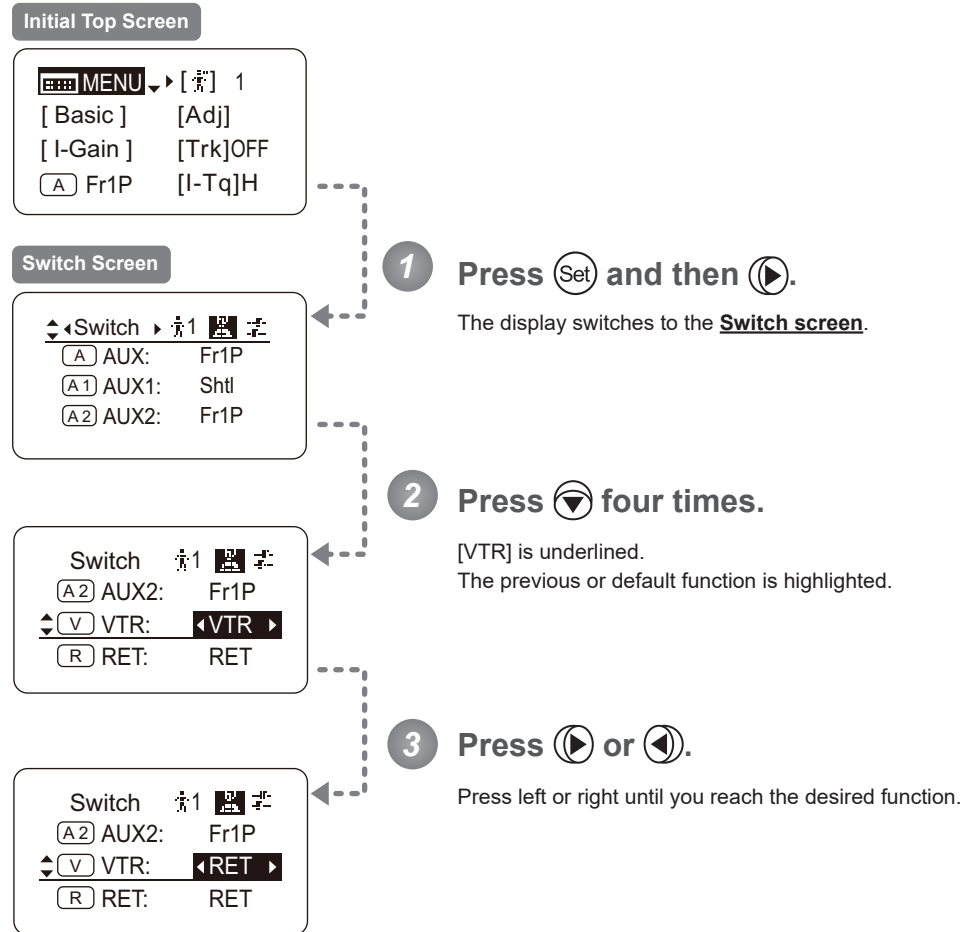

Options	Fr1P	Fr1F	Fr2P	Fr2F	Sped	Shtl	^(D) VTR	RET
Description	Framing Preset1 switch (preset speed)	Framing Preset1 switch (max. speed)	Framing Preset2 switch (preset speed)	Framing Preset2 switch (max. speed)	Speed Preset switch	Shuttle-Shot switch	VTR switch	RET switch

(D): Default value



Assigning Functions to the RET Switch Top

The RET switch can be programmed to activate a function of your choice.

Important

First, switch to the user for whom the settings apply.

(For instructions, see “4.1.3 Switching Users” or “4.2.1 User Screen Settings: Switching Users.”)

Initial Top Screen

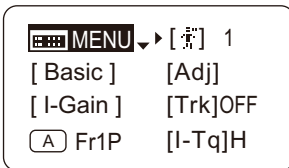

Switch Screen

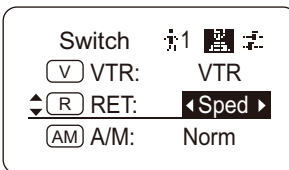
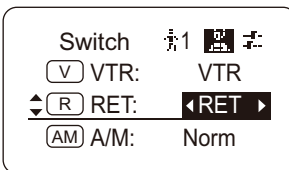
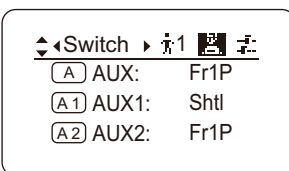

1 Press and then .

The display switches to the **Switch screen**.

2 Press five times.

[RET] is underlined.

The previous or default function is highlighted.

3 Press or .

Press left or right until you reach the desired function.

Options	Fr1P	Fr1F	Fr2P	Fr2F	Sped	Shtl	VTR	^(D) RET
Description	Framing Preset1 switch (preset speed)	Framing Preset1 switch (max. speed)	Framing Preset2 switch (preset speed)	Framing Preset2 switch (max. speed)	Speed Preset switch	Shuttle-Shot switch	VTR switch	RET switch

(D): Default value



Specifying Iris A/M Switch Top

The Iris A/M switch can be programmed to activate a function of your choice.

Important

First, switch to the user for whom the settings apply.

(For instructions, see “4.1.3 Switching Users” or “4.2.1 User Screen Settings: Switching Users.”)

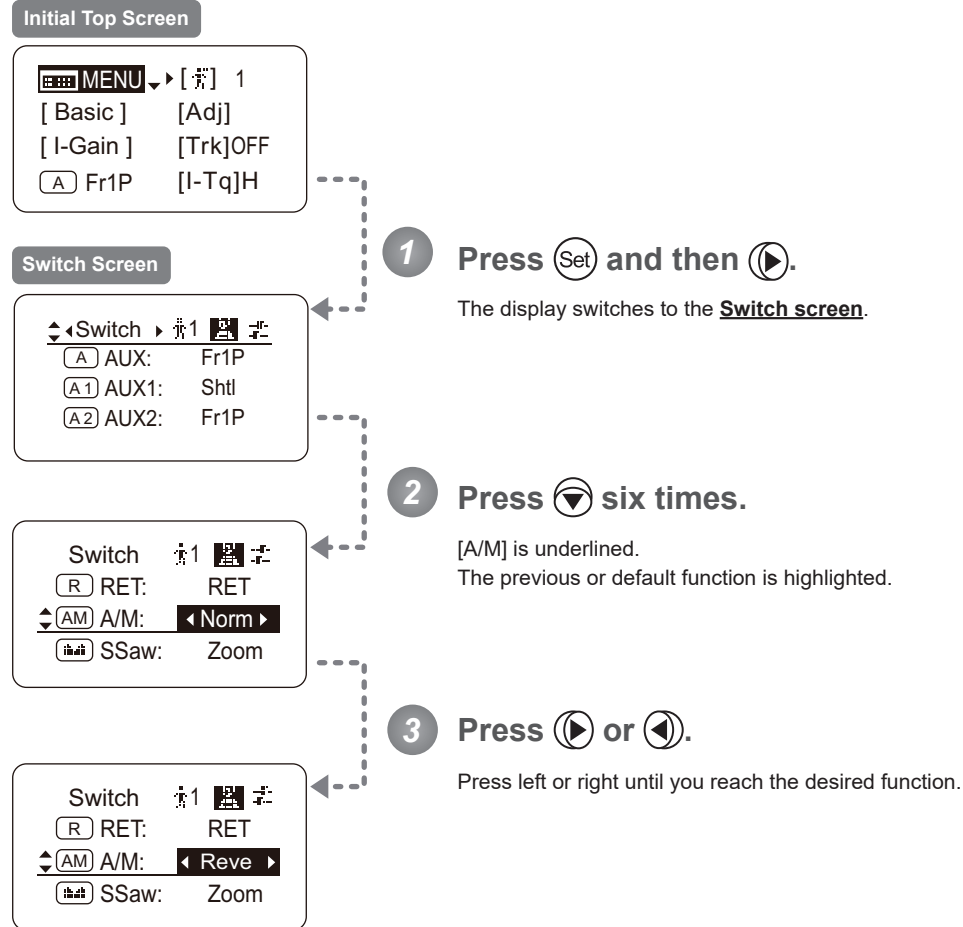

Options	^(D) Norm	Reve	Auto	Manu
Description	Normal operation A: Auto / M: Manual	Reverse operation A: Manual / M: Auto	Auto Only A: Auto / M: Auto	Manual Only A: Manual / M: Manual

(D): Default value



Assigning Functions to the Seesaw Top

The zoom seesaw switch can be programmed to control either the {Zoom} or {Iris}.

Important

First, switch to the user for whom the settings apply.

(For instructions, see “4.1.3 Switching Users” or “4.2.1 User Screen Settings: Switching Users.”)

Initial Top Screen

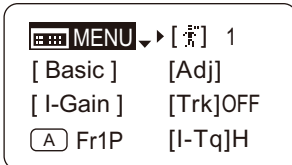

Switch Screen

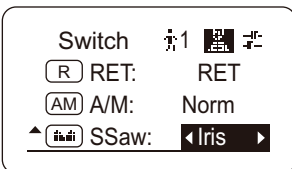
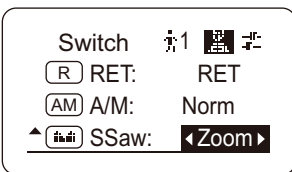
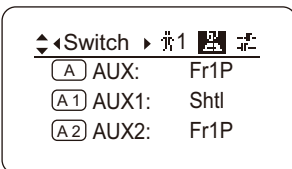

1 Press **Set** and then **▶**.

The display switches to the **Switch screen**.

2 Press **▼** seven times.

[SSaw] is underlined.

The previous or default function is highlighted.

3 Press **▶** or **◀**.

Press left or right until you reach the desired function.

Note: Note on Iris Assignment

1. The seesaw switch will no longer control zooming.
2. To control the iris with the rocker switch, you must set the iris mode to manual. Operation is not possible in Auto or Remote mode.
3. Press the Telephoto side to open the iris, or press the Wide end side to close it.
4. Zoom speed control adjustments also apply to iris control, and you can specify the maximum iris speed. (See “4.2.5 Zoom Screen Settings: Specifying Maximum Zoom Speed Control.”)

Options	^(D) Zoom	Iris
Description	Zoom operation	Iris operation

(D): Default value



4.2.3 Preset Screen Settings

The following setting items can be configured on the **Preset screen**.

Switching What Frame Preset 1 Controls

Switching What Frame Preset 2 Controls

Specifying the Preset Mode Zoom Speed

Specifying Zoom Start Responsiveness for Presets

Specifying Zoom Stop Responsiveness for Presets

Switching What Frame Preset 1 Controls

Switch what frame preset 1 controls, as needed.

- Zoom : Move the zoom position to the position in memory
- Focus : Move the focus position to the position in memory
- Z+F : Move the zoom and focus position to the position in memory

Important

First, switch to the user for whom the settings apply.
 (For instructions, see “4.1.3 Switching Users” or “4.2.1 User Screen Settings: Switching Users.”)

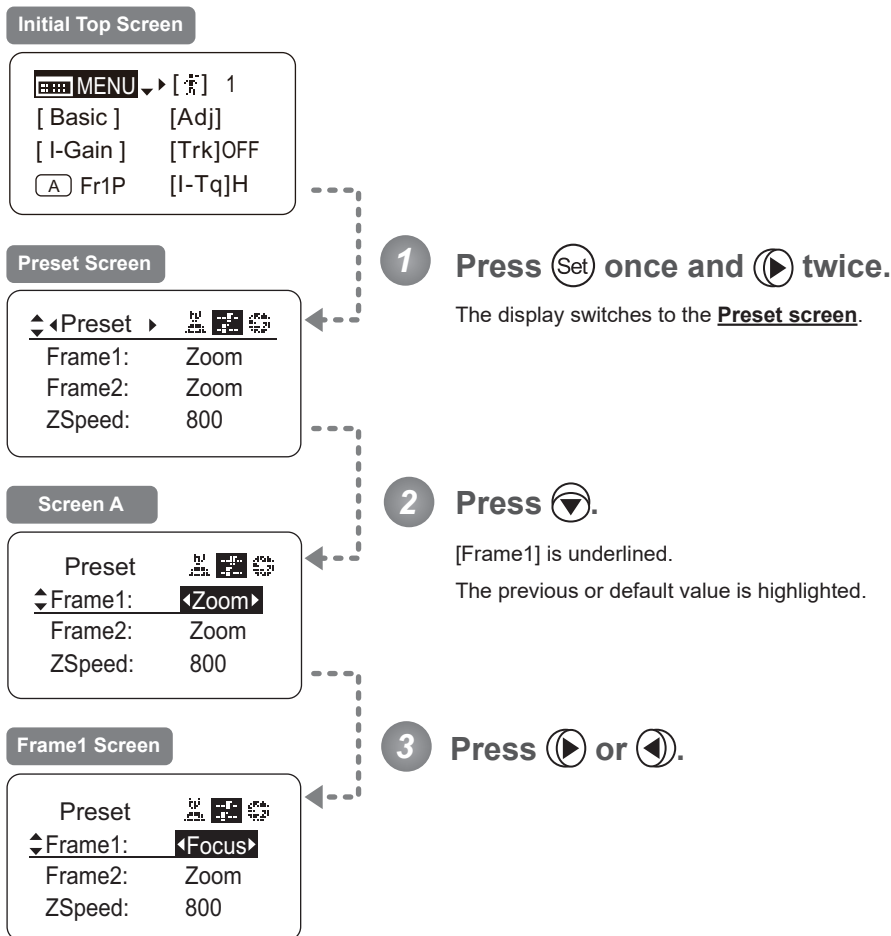

Options	^(D) Zoom	Focus	Z+F
Description	Control zooming	Control focusing	Control zooming and focusing

(D): Default value

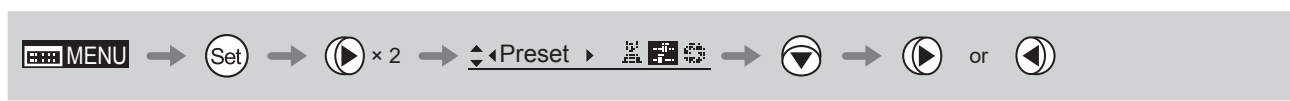

Switching What Frame Preset 2 Controls

Switch what frame preset 2 controls, as needed.

- Zoom : Move the zoom position to the position in memory
- Focus : Move the focus position to the position in memory
- Z+F : Move the zoom and focus position to the position in memory

Important

First, switch to the user for whom the settings apply.

(For instructions, see “4.1.3 Switching Users” or “4.2.1 User Screen Settings: Switching Users.”)

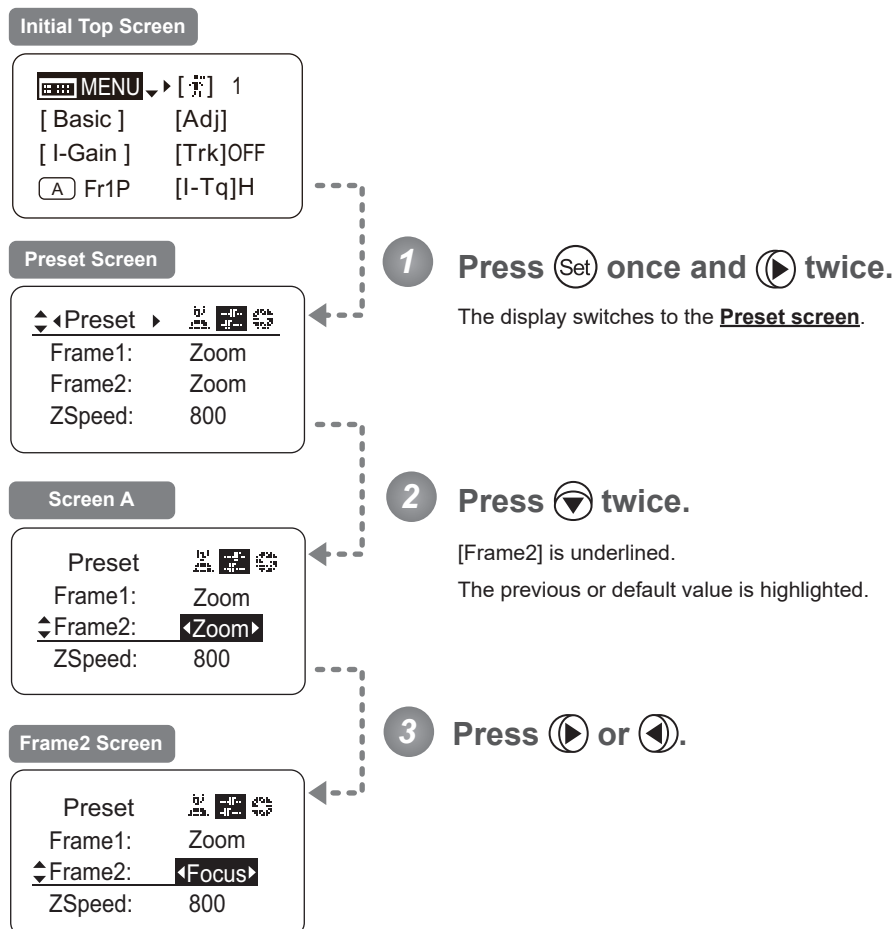

Options	^(D) Zoom	Focus	Z+F
Description	Control zooming	Control focusing	Control zooming and focusing

(D): Default value

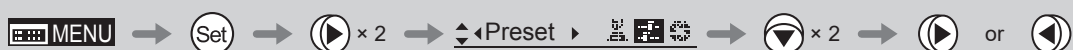

Specifying the Preset Mode Zoom Speed

Configure the zoom speed from any position to the position in memory, as needed.

To adjust the value, use either the Memo button (refer to the operation manual "Lens") or display operations.

Regardless of the method of adjustment used, the most recent setting takes precedence.

Important

First, switch to the user for whom the settings apply.

(For instructions, see "4.1.3 Switching Users" or "4.2.1 User Screen Settings: Switching Users.")

Initial Top Screen

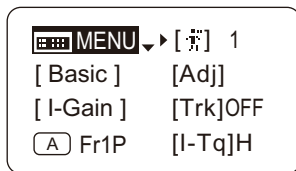

Preset Screen

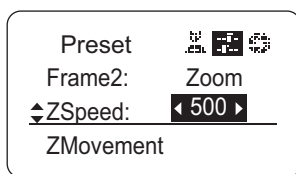
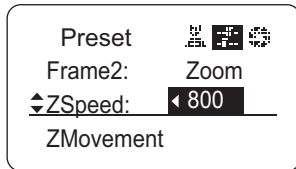
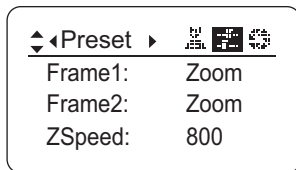

Note: Your specified values apply to both Fr1P and Fr2P.

1 Press **Set** once and **▶** twice.

The display switches to the **Preset screen**.

2 Press **▼** three times.

[ZSpeed] is underlined.

The previous or default value is highlighted.

3 Press **▶** or **◀**.

Press left or right until you reach the desired value.

Options	1	to	(D) 800
Description	Slowest		Fastest

(D): Default value



Specifying Zoom Start Responsiveness for Presets

Specify initial responsiveness in zooming for preset operations.

Initial Top Screen

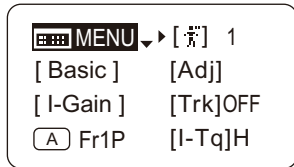

Preset Screen

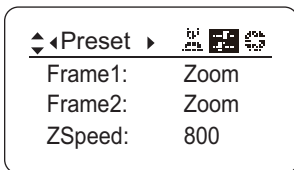

Screen A

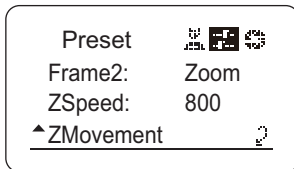

ZMovement Screen

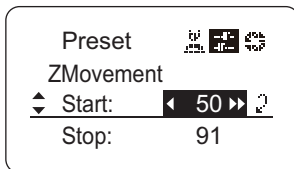
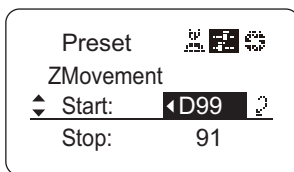
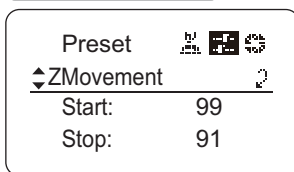

Important

First, switch to the user for whom the settings apply.
(For instructions, see “4.1.3 Switching Users” or “4.2.1 User Screen Settings: Switching Users.”)

1 Press **Set** once and **Play** twice.

The display switches to the **Preset screen**.

2 Press **Down Arrow** four times.

[ZMovement] is underlined.

3 Press **Set**.

The display switches to the **ZMovement screen**.

4 Press **Down Arrow**.

[Start] is underlined.

The previous or default value is highlighted.

5 Press **Play** or **Left Arrow**.

Press left or right until you reach the desired value.

6 Press **Set**.

The display reverts to **Screen A**.

Options	00	to	^(D) 99
Description	Start gradually		Start quickly

(D): Default value



Specifying Zoom Stop Responsiveness for Presets

Specify final responsiveness in zooming for preset operations.

Important

First, switch to the user for whom the settings apply.
(For instructions, see “4.1.3 Switching Users” or “4.2.1 User Screen Settings: Switching Users.”)

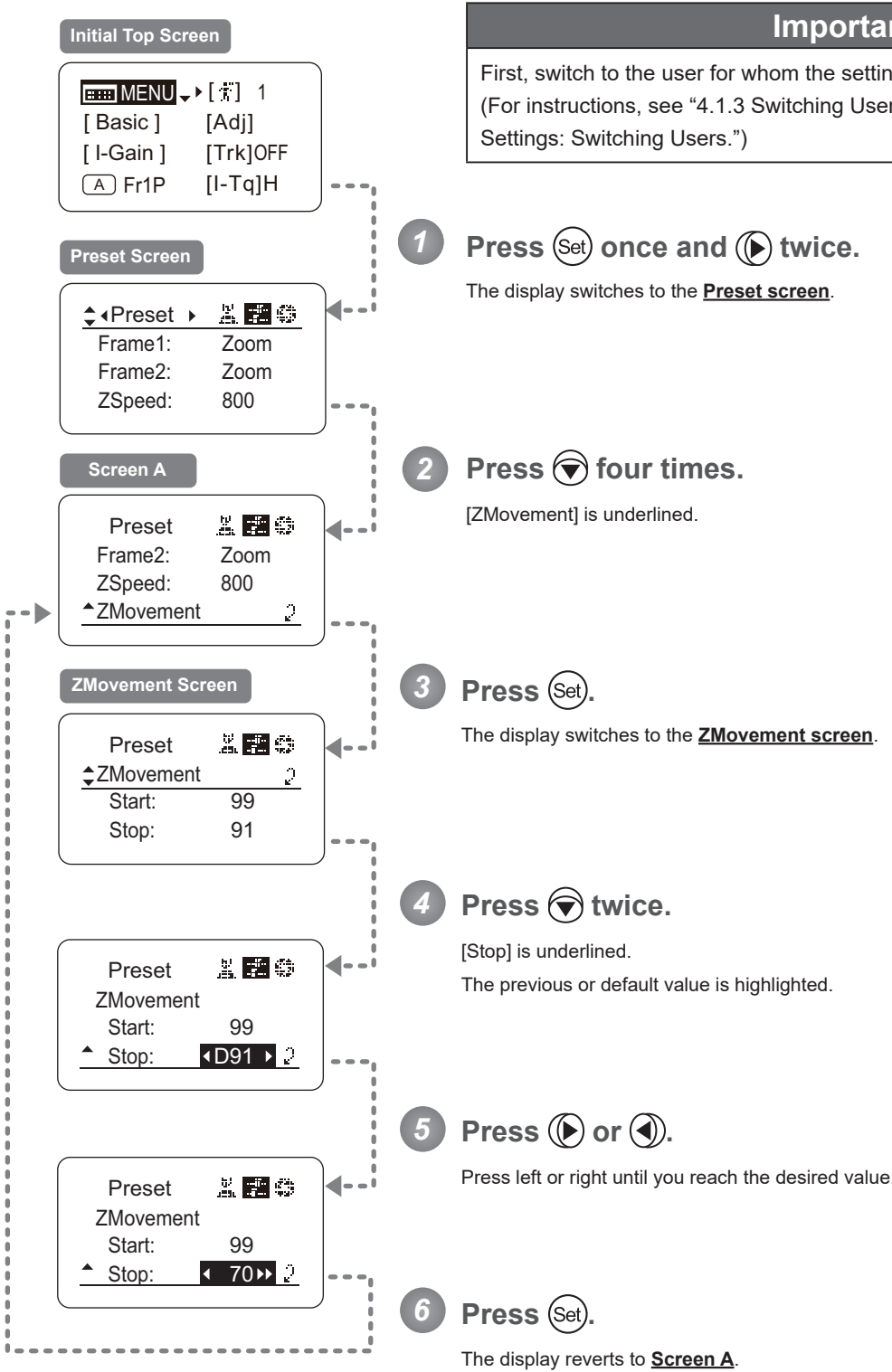

- 1 Press once and twice.**
The display switches to the **Preset screen**.
- 2 Press four times.**
[ZMovement] is underlined.
- 3 Press .**
The display switches to the **ZMovement screen**.
- 4 Press twice.**
[Stop] is underlined.
The previous or default value is highlighted.
- 5 Press or .**
Press left or right until you reach the desired value.
- 6 Press .**
The display reverts to **Screen A**.

Options	00	to	99
Description	Stop gradually		Stop quickly

Default value: 91



4.2.4 Iris Screen Settings

The following setting items can be configured on the Iris screen.

Specifying Iris Gain

(1) Specifying Auto Iris Gain

Top

(2) Specifying Remote Iris Gain

Top

Specifying Iris Torque

Top

Iris Compensation ON/OFF

Iris Close Detection ON/OFF

Focus Demand Iris Control ON/OFF

Items labeled **Top** can also be modified from the Top screen.

Specifying Iris Gain

(1) Specifying Auto Iris Gain

Top

Although this value is factory-set, it can be adjusted as needed.

To adjust the value, use either the auto iris gain adjustment trimmer (refer to the operation manual "Lens") or display operations.

Regardless of the method of adjustment used, the most recent setting takes precedence.

The same auto iris gain value applies to all users, regardless of the current user. Thus, there is no need to switch users in advance. Unlike most other setting adjustments, any changes to this setting also apply to user 0.

Initial Top Screen

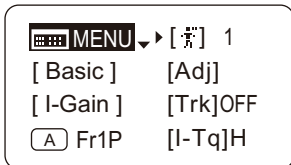

Iris Screen

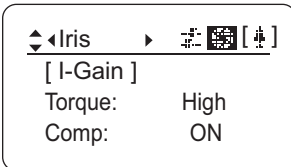

Screen A

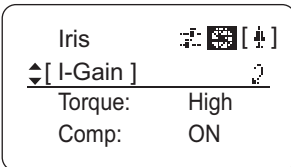

[I-Gain] Screen

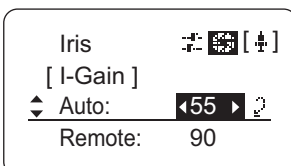
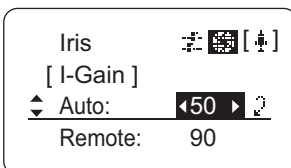
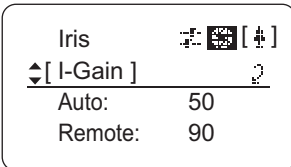

1 Press **Set** once and **Play** three times.

The display switches to the Iris screen.

Note: Do the following when adjusting gain while checking iris operation.

- Confirm that the drive unit A/M switch is set to [Auto] mode.
- Set the camera iris mode to [Auto].

2 Press **Down Arrow**.

[I-Gain] is underlined.

Note: As you look at the lens iris ring, set it to the position of maximum gain at which "focus hunting" does not occur.

3 Press **Set**.

The display switches to the [I-Gain] screen.

Note: The current iris gain value is retained even if you reset other settings as described in "4.2.1 Resetting Values." For this reason, you will no longer be able to view the default setting. If necessary, make a note of the default setting before adjusting this value.

4 Press **Down Arrow**.

[Auto] is underlined.

The previous or default value is highlighted.

5 Press **Play** or **Left Arrow**.

Press left or right until you reach the desired function.

6 Press **Set**.

The display reverts to Screen A.

Options	01	to	99
Description	Minimum gain		Maximum gain

Default: Varies depending on the factory-set value, but corresponds to the value determined with the iris gain adjustment trimmer.



(2) Specifying Remote Iris Gain Top

Although this value is factory-set, it can be adjusted as needed.

The same remote iris gain value applies to all users, regardless of the current user. Thus, there is no need to switch users in advance. Unlike most other setting adjustments, any changes to this setting also apply to user 0.

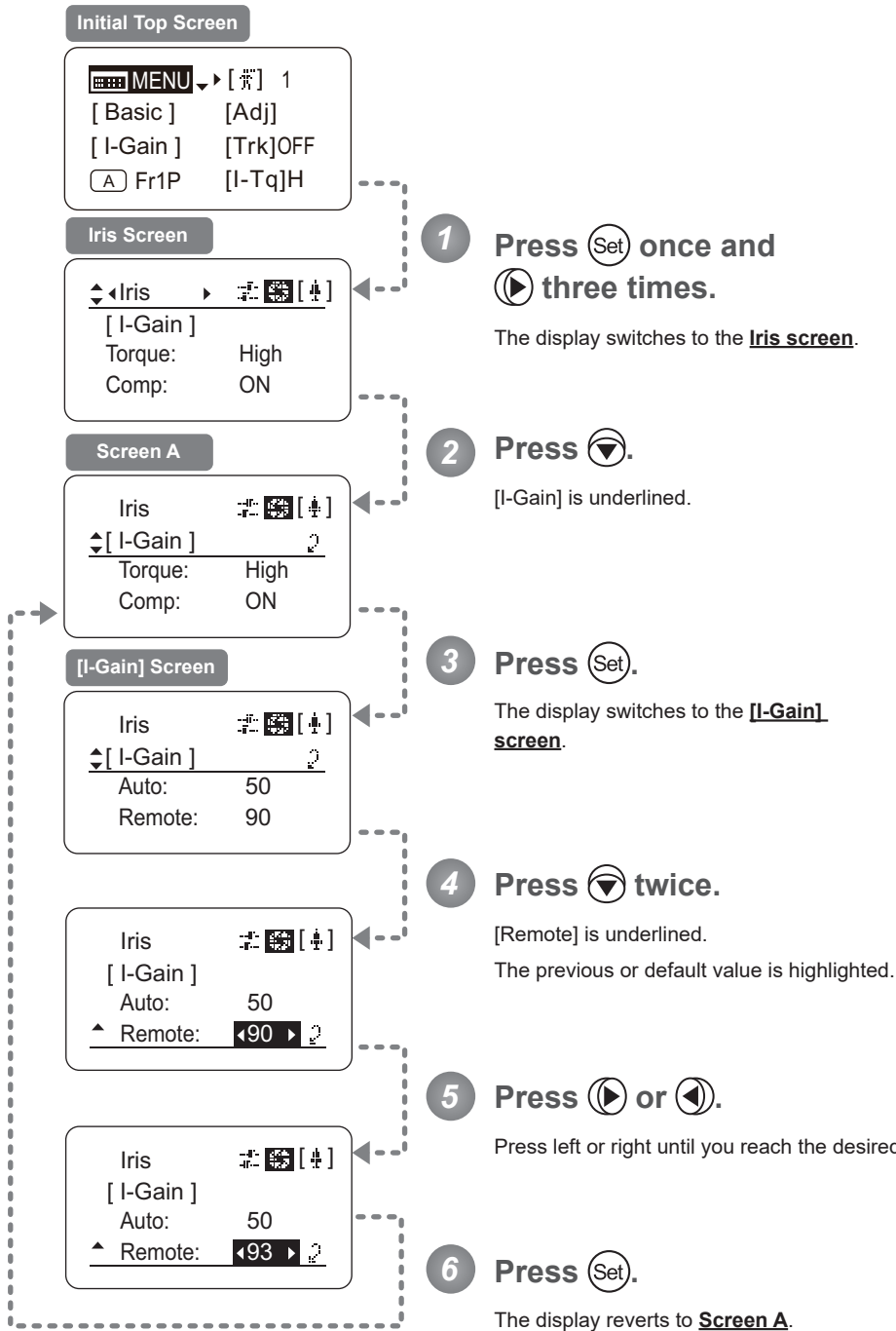

Note: Do the following when adjusting gain while checking iris operation.

- Confirm that the drive unit A/M switch is set to [Auto] mode.
- Set the camera iris mode to [Remote].

Note: The current iris gain value is retained even if you reset other settings as described in "4.2.1 Resetting Values." For this reason, you will no longer be able to view the default setting. If necessary, make a note of the default setting before adjusting this value.

Options	01	to	99
Description	Minimum gain		Maximum gain

Default value: 90

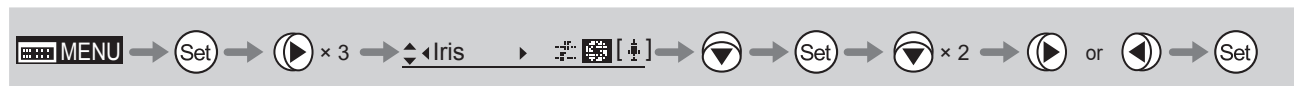

Specifying Iris Torque Top

Specify the desired level of torque in manual control of the iris ring.

Important

First, switch to the user for whom the settings apply.

(For instructions, see “4.1.3 Switching Users” or “4.2.1 User Screen Settings: Switching Users.”)

Initial Top Screen

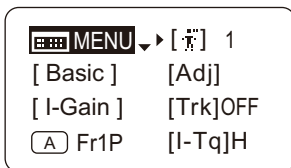

Iris Screen

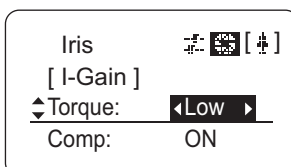
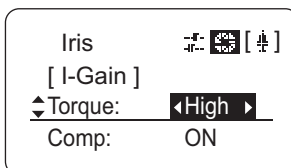
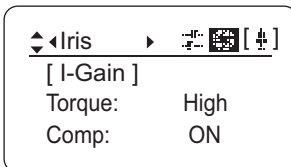

1 Press once and three times.

The display switches to the Iris screen.

2 Press twice.

[Torque] is underlined.

The previous or default function is highlighted.

3 Press or .

Press left or right to switch the function to {High} or {Low}.

Options	^(D) High	Low
Description	High torque	Low torque

(D): Default value

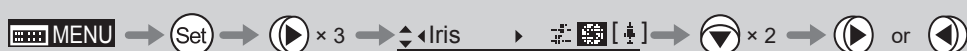

Iris Compensation ON/OFF

The amount of light decreases when an extender (1.5×) is used. Therefore, you can set a function that corrects the iris to the open side so as to maintain the amount of light.

Important



First, switch to the user for whom the settings apply.

(For instructions, see “4.1.3 Switching Users” or “4.2.1 User Screen Settings: Switching Users.”)

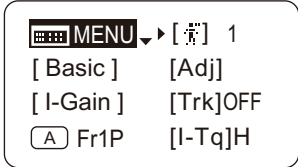
Initial Top Screen



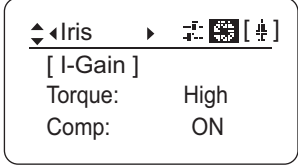

Iris Screen

1 Press  once and  three times.
The display switches to the **iris screen**.

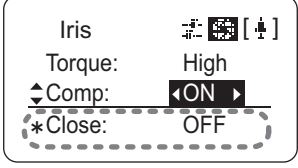

2 Press  three times.
[Comp] is underlined.
The previous or default function is highlighted.



3 Press  or .
Press left or right to switch the function {ON} or {OFF}.

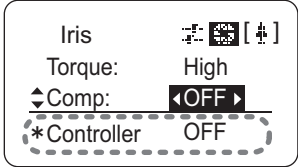

*: Displayed when {Comp} is set to ON.

*: Displayed when {Comp} is set to OFF.

Note: The iris may not fully close in some cases when the iris compensation is set to ON while an extender (1.5×) is used. If so, activate detection as described in “Iris Close Detection ON/OFF.”

Options	^(D) ON	OFF
Description	Iris compensation	No iris compensation

(D): Default value

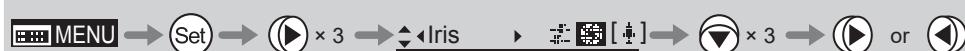

Iris Close Detection ON/OFF

The iris cannot be fully closed when correction is active and an extender (1.5×) is used. As a countermeasure, you can specify a function to detect iris close and close the iris as needed.

Important

First, switch to the user for whom the settings apply.
(For instructions, see “4.1.3 Switching Users” or “4.2.1 User Screen Settings: Switching Users.”)

Initial Top Screen

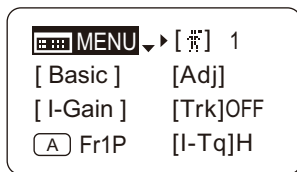

Iris Screen

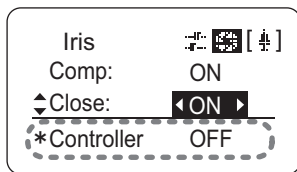
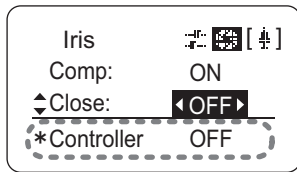
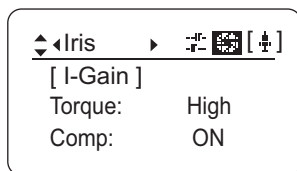

1 Press **Set** once and **Enter** three times.

The display switches to the Iris screen.

2 Press **Down** four times.

[Close] is underlined.
The previous or default function is highlighted.

3 Press **Right** or **Left**.

Press left or right to switch the function {ON} or {OFF}.

Note: With some cameras, iris compensation may conflict with iris control by the camera, preventing correct iris operation. If so, deactivate iris close detection.

*: Displayed when {Comp} is set to ON.

Note: Iris close is detected only when iris compensation is enabled.

Options	^(D) OFF	ON
Description	No close detection	Close detection

(D): Default value

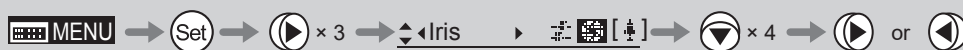

Focus Demand Iris Control ON/OFF

Iris operations using a focus demand can be switched on or off.

Important

First, switch to the user for whom the settings apply.

(For instructions, see “4.1.3 Switching Users” or “4.2.1 User Screen Settings: Switching Users.”)

Initial Top Screen

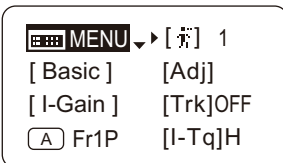

Iris Screen

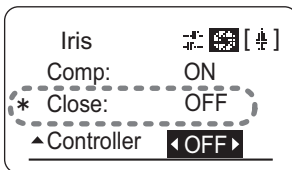
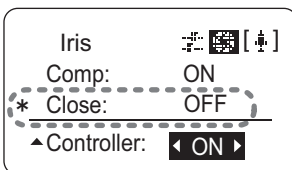
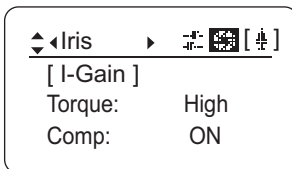

1 Press once and three times.

The display switches to the **Iris screen**.

2 Press five times.

[Controller] is underlined.

The previous or default function is highlighted.

*: Displayed when {Comp} is set to ON.

3 Press or .

Press left or right to switch the function {ON} or {OFF}.

Options	ON	^(D) OFF
Description	Iris controlled with focus demand	Iris not controlled with focus demand

(D): Default value

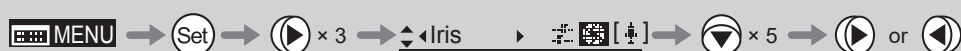

4.2.5 Zoom Screen Settings

The following setting items can be configured on the Zoom screen.

- Zoom Tracking ON/OFF **Top**
- Specifying Zoom Servo Start Responsiveness
- Specifying Zoom Servo Stop Responsiveness
- Specifying Zoom Mechanical End Stop Responsiveness
- Specifying Seesaw Switch Responsiveness **Top**
- Specifying Analog Demand Responsiveness **Top**
- Specifying Maximum Zoom Speed Control
- Specifying Minimum Zoom Speed Control
- Specifying Servo Type from Zoom Demand
- Demand-Based Zoom Speed Adjustment ON/OFF
- Specifying Zoom Demand Specifications

Items labeled **Top** can also be modified from the Top screen.

Zoom Tracking ON/OFF Top

Activate or deactivate zoom tracking as needed.

Important

First, switch to the user for whom the settings apply.

(For instructions, see "4.1.3 Switching Users" or "4.2.1 User Screen Settings: Switching Users.")

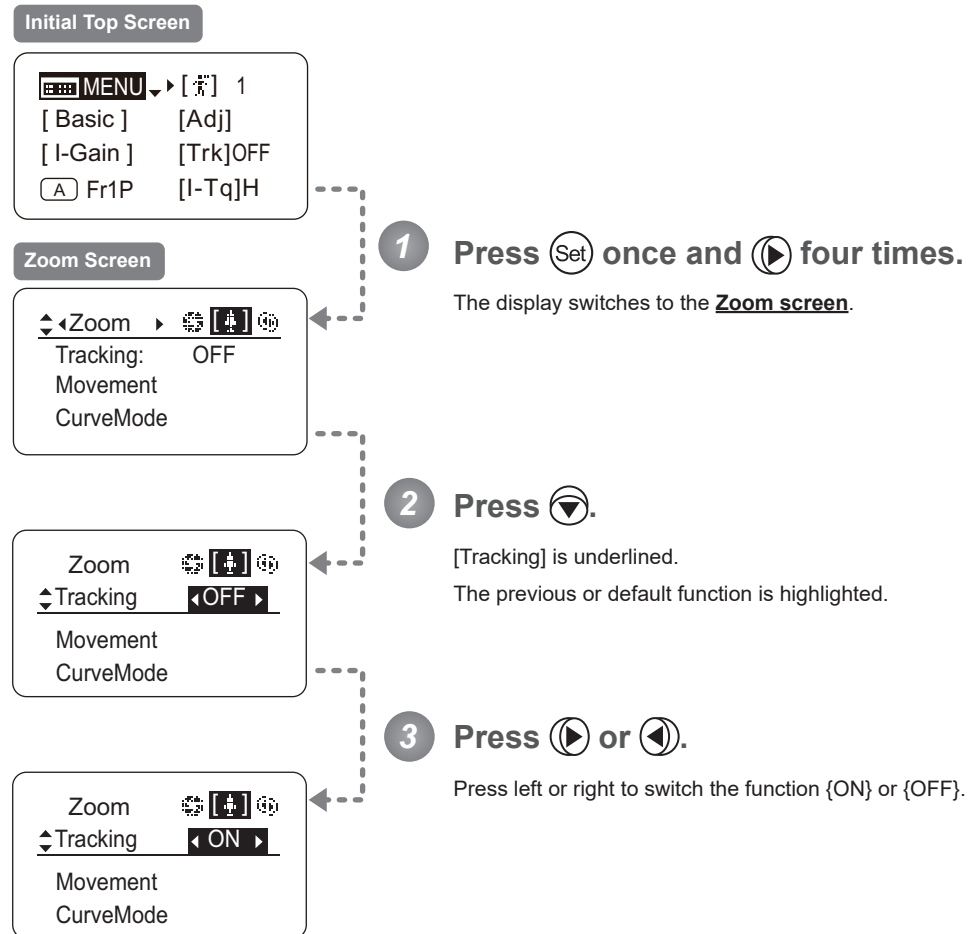

Options	^(D) OFF	ON
Description	Zoom tracking disabled	Zoom tracking enabled

(D): Default value

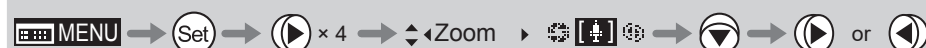

Specifying Zoom Servo Start Responsiveness

Specify initial responsiveness in zooming (using seesaw switch, for example) as needed.

Important

First, switch to the user for whom the settings apply.

(For instructions, see “4.1.3 Switching Users” or “4.2.1 User Screen Settings: Switching Users.”)

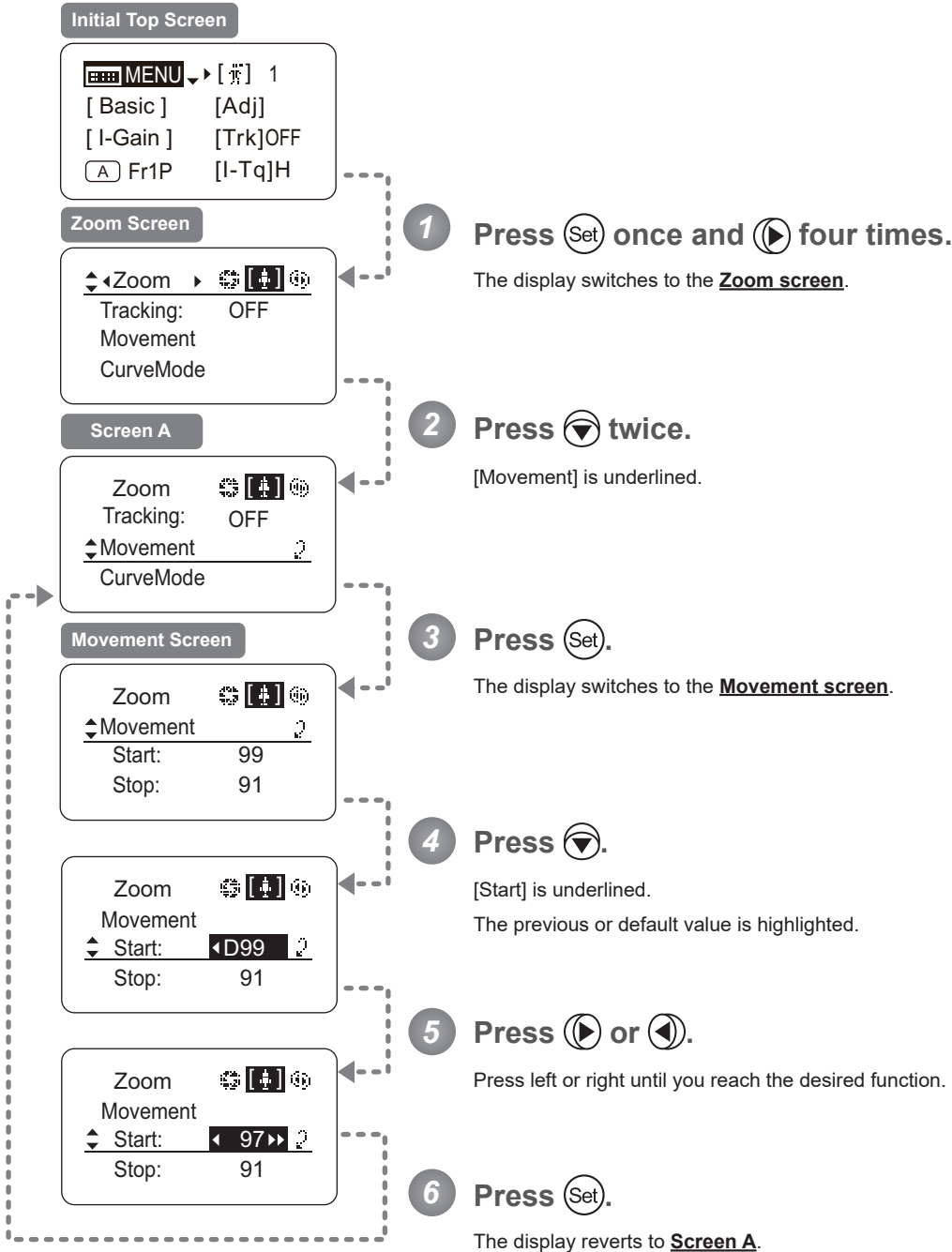

Options	00	to	^(D) 99
Description	Start gradually		Start quickly

(D): Default value



Specifying Zoom Servo Stop Responsiveness

Specify final responsiveness in zooming (using seesaw switch, for example) as needed.

Important

First, switch to the user for whom the settings apply.

(For instructions, see “4.1.3 Switching Users” or “4.2.1 User Screen Settings: Switching Users.”)

Initial Top Screen

MENU ▾ ▶ [] 1
[Basic] [Adj]
[I-Gain] [Trk]OFF
[A] Fr1P [I-Tq]H

Zoom Screen

◀Zoom ▶ [] [] []
Tracking: OFF
Movement
CurveMode

Screen A

Zoom [] [] []
Tracking: OFF
◀Movement ▶ [] []
CurveMode

Movement Screen

Zoom [] [] []
◀Movement ▶ [] []
Start: 99
Stop: 91

Zoom [] [] []
Movement
◀Stop: ▶ D91 ▶ [] []
End: 99

Zoom [] [] []
Movement
◀Stop: ▶ 89 ▶ [] []
End: 99

1 Press (Set) once and (▶) four times.

The display switches to the **Zoom screen**.

2 Press (▼) twice.

[Movement] is underlined.

3 Press (Set).

The display switches to the **Movement screen**.

4 Press (▼) twice.

[Start] is underlined.

The previous or default value is highlighted.

5 Press (▶) or (◀).

Press left or right until you reach the desired function.

6 Press (Set).

The display reverts to **Screen A**.

Options	00	to	99
Description	Stop gradually		Stop quickly

Default value: 91



Specifying Zoom Mechanical End Stop Responsiveness

Specify final responsiveness at the mechanical end in zooming (using the seesaw switch, for example) as needed.

Important

First, switch to the user for whom the settings apply.

(For instructions, see “4.1.3 Switching Users” or “4.2.1 User Screen Settings: Switching Users.”)

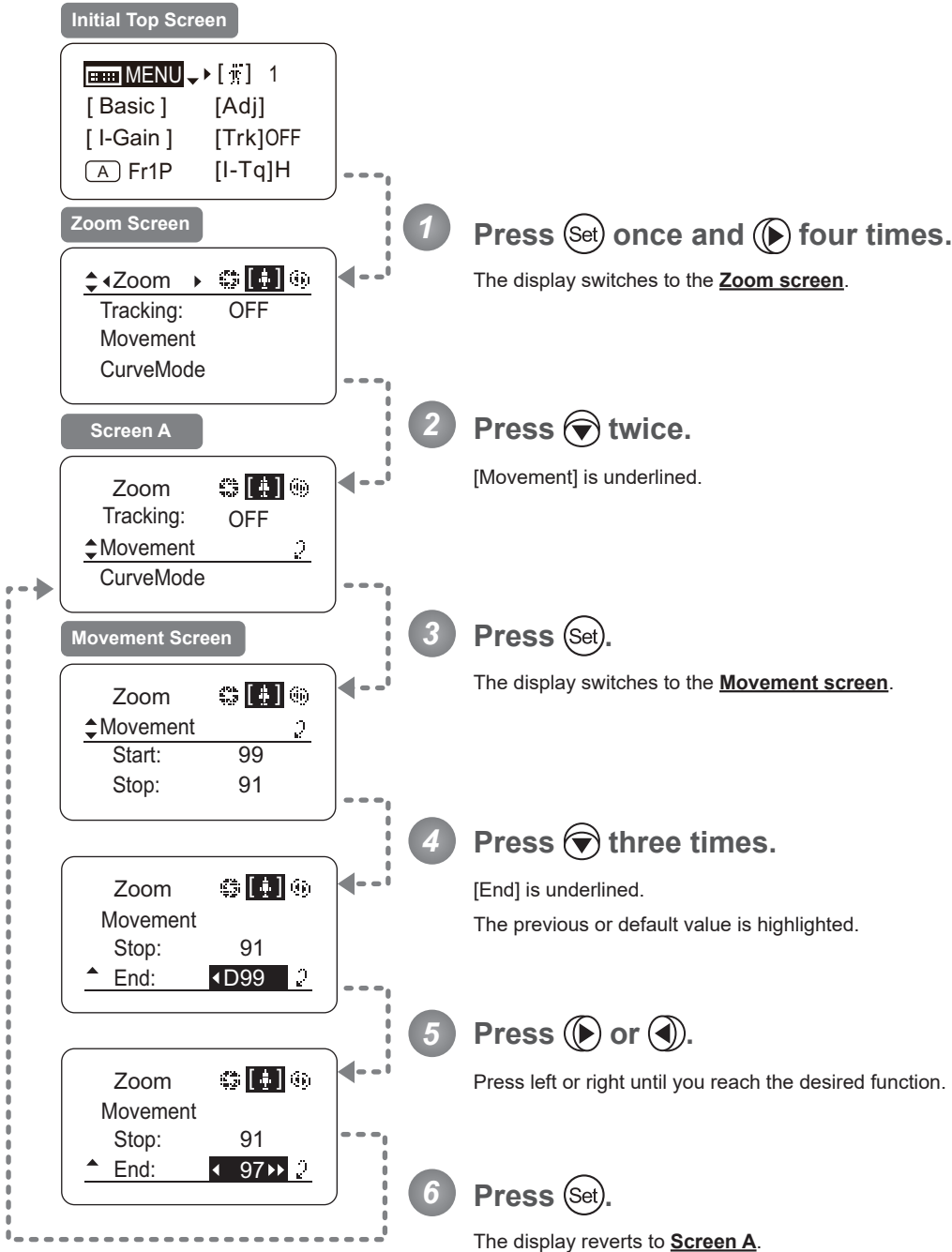

Options	00	to	^(D) 99
Description	Stop gradually		Stop quickly

(D): Default value



Specifying Seesaw Switch Responsiveness Top

Configure the responsiveness of zoom speed adjustment in response to pressing the zoom seesaw switch.
 (Note: Another screen is displayed when this setting is configured.)

Important

First, switch to the user for whom the settings apply.
 (For instructions, see "4.1.3 Switching Users" or "4.2.1 User Screen Settings: Switching Users.")

Initial Top Screen

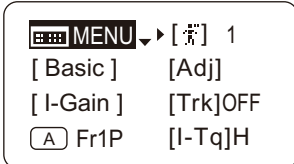

Zoom Screen

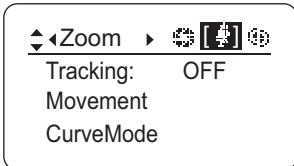

Screen A

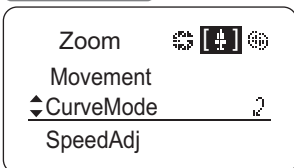

CurveMode Screen

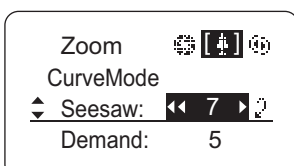
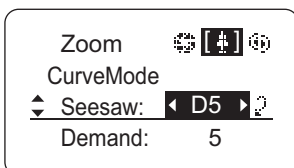
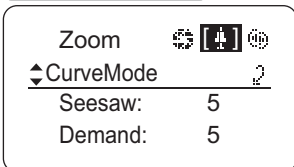

- 1** Press **Set** once and **▶** four times.
The display switches to the **Zoom screen**.
- 2** Press **▼** three times.
[CurveMode] is underlined.
- 3** Press **Set**.
The display switches to the **CurveMode screen**.
- 4** Press **▼**.
[Seesaw] is underlined.
The previous or default value is highlighted.
- 5** Press **▶** or **◀**.
Press left or right until you reach the desired function.
- 6** Press **Set**.
The display reverts to **Screen A**.

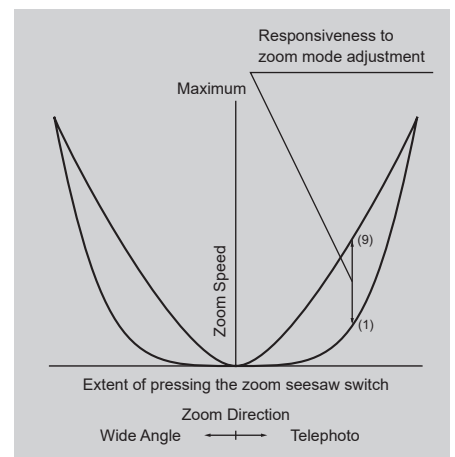

Options	1	2	3	4	(D) 5	6	7	8	9
---------	---	---	---	---	-------	---	---	---	---

(D): Default value



Specifying Analog Demand Responsiveness Top

Configure the responsiveness of zoom speed adjustment in response to pressing the analog demand thumb ring.
 (Note: Another screen is displayed when this setting is configured.)

Important

First, switch to the user for whom the settings apply.
 (For instructions, see “4.1.3 Switching Users” or “4.2.1 User Screen Settings: Switching Users.”)

Initial Top Screen

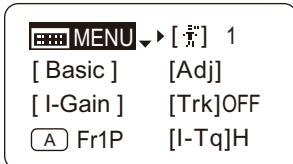

Zoom Screen

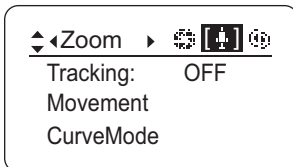

Screen A

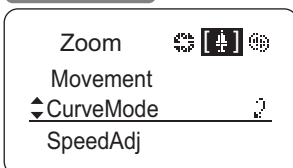

CurveMode Screen

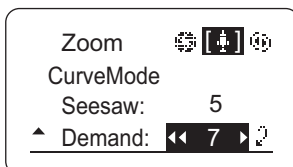
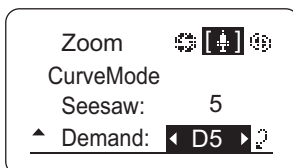
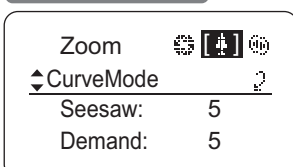

1 Press **Set** once and **▶** four times.

The display switches to the **Zoom screen**.

2 Press **▼** three times.

[CurveMode] is underlined.

3 Press **Set**.

The display switches to the **CurveMode screen**.

4 Press **▼** twice.

[Demand] is underlined.
 The previous or default value is highlighted.

5 Press **▶** or **◀**.

Press left or right until you reach the desired function.

6 Press **Set**.

The display reverts to **Screen A**.

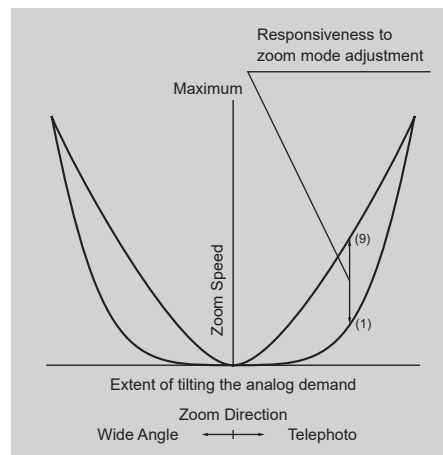

Options	1	2	3	4	(D) 5	6	7	8	9
---------	---	---	---	---	-------	---	---	---	---

(D): Default value



Specifying Maximum Zoom Speed Control

Specify the maximum speed to which the zoom speed can be adjusted using the drive unit knob.

Important

First, switch to the user for whom the settings apply.

(For instructions, see “4.1.3 Switching Users” or “4.2.1 User Screen Settings: Switching Users.”)

Initial Top Screen

MENU ▾ [F] 1
[Basic] [Adj]
[I-Gain] [Trk]OFF
[A] Fr1P [I-Tq]H

Zoom Screen

Zoom ▸ [F] [G] [H]
Tracking: OFF
Movement
CurveMode

Screen A

Zoom [F] [G] [H]
CurveMode
SpeedAdj 2
Control: Sped

SpeedAdj Screen

Zoom [F] [G] [H]
SpeedAdj 2
Max: 99
Min: 01

Zoom [F] [G] [H]
SpeedAdj
Max: ◀D99 2
Min: 01

Zoom [F] [G] [H]
SpeedAdj
Max: ◀97▶ 2
Min: 01

- 1 Press **Set** once and **▶** four times.

The display switches to the **Zoom screen**.

- 2 Press **▼** four times.

[SpeedAdj] is underlined.

- 3 Press **Set**.

The display switches to the **SpeedAdj screen**.

- 4 Press **▼**.

[Max] is underlined.

The previous or default value is highlighted.

- 5 Press **▶** or **◀**.

Press left or right until you reach the desired function.

- 6 Press **Set**.

The display reverts to **Screen A**.

Options	Min. value ^(D) 99
---------	------------------------------

(D): Default value



Specifying Minimum Zoom Speed Control

Specify the minimum speed to which the zoom speed can be adjusted using the drive unit knob.

Important

First, switch to the user for whom the settings apply.
(For instructions, see “4.1.3 Switching Users” or “4.2.1 User Screen Settings: Switching Users.”)

Initial Top Screen

MENU ▾ [1] 1
[Basic] [Adj]
[I-Gain] [Trk]OFF
[A] Fr1P [I-Tq]H

Zoom Screen

Zoom ▾ [4] [00]
Tracking: OFF
Movement
CurveMode

Screen A

Zoom [4] [00]
CurveMode
SpeedAdj 2
Control: Sped

SpeedAdj Screen

Zoom [4] [00]
SpeedAdj 2
Max: 99
Min: 01

Zoom [4] [00]
SpeedAdj
Max: 99
Min: D01 [2]

Zoom [4] [00]
SpeedAdj
Max: 99
Min: 03 [2]

1 Press **Set** once and **▶** four times.

The display switches to the **Zoom screen**.

2 Press **▼** four times.

[SpeedAdj] is underlined.

3 Press **Set**.

The display switches to the **SpeedAdj screen**.

4 Press **▼** twice.

[Min] is underlined.

The previous or default value is highlighted.

5 Press **▶** or **◀**.

Press left or right until you reach the desired function.

6 Press **Set**.

The display reverts to **Screen A**.

Options

^(D) 01–Max. value

(D): Default value



Specifying Servo Type from Zoom Demand

Specify either the speed or position servo as the type of servo to use from the zoom demand.

Important

First, switch to the user for whom the settings apply.

(For instructions, see “4.1.3 Switching Users” or “4.2.1 User Screen Settings: Switching Users.”)

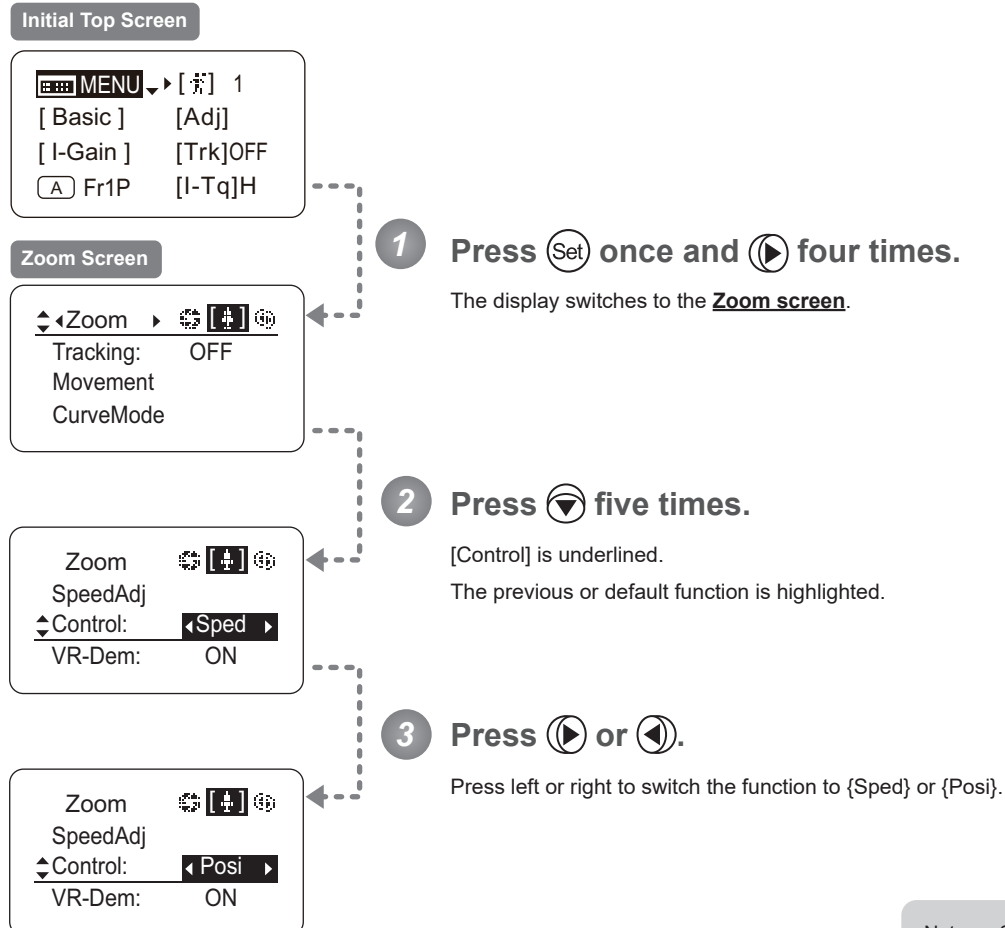

Note: Selecting {Posi} will disable the seesaw switch. Additionally, only one demand connector can be connected when {Posi} is selected. Normally, select {Sped}.

Options	^(D) Sped	Posi
Description	Speed servo	Position servo

(D): Default value

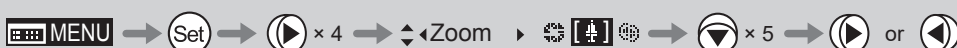

Demand-Based Zoom Speed Adjustment ON/OFF

Enable or disable adjustment of the maximum drive unit zoom speed based on the zoom demand.

Important

First, switch to the user for whom the settings apply.
 (For instructions, see “4.1.3 Switching Users” or “4.2.1 User Screen Settings: Switching Users.”)

Initial Top Screen

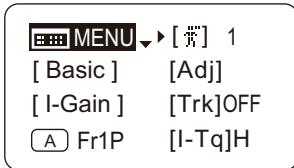

Zoom Screen

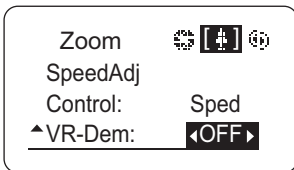
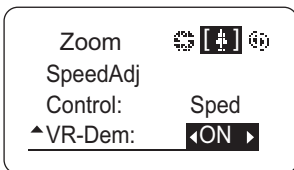
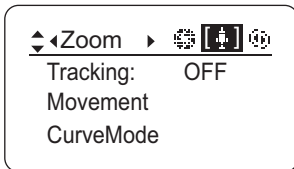

1 Press **Set** once and **▶** four times.

The display switches to the **Zoom screen**.

2 Press **▼** six times.

[VR-Dem] is underlined.

The previous or default function is highlighted.

3 Press **▶** or **◀**.

Press left or right to switch the function {ON} or {OFF}.

Options	^(D) ON	OFF
Description	Enabled	Disabled

(D): Default value

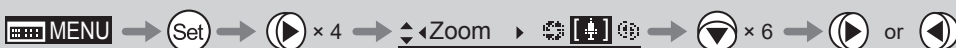

4.2.6 Focus Screen Settings

The following setting items can be configured on the **Focus screen**.

Specifying Focus Demand Responsiveness

Specifying Focus Demand Responsiveness

Specify responsiveness in analog focus demand operations as needed.

Note: These settings take effect when the curve selection switch on the focus demand is set toward FAR.

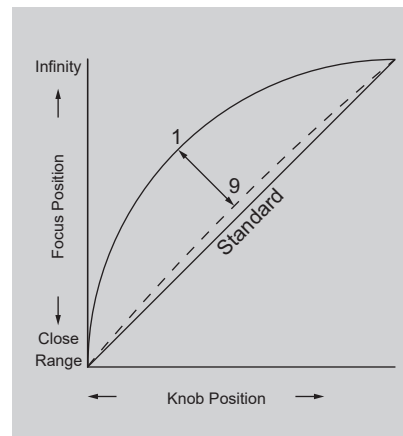
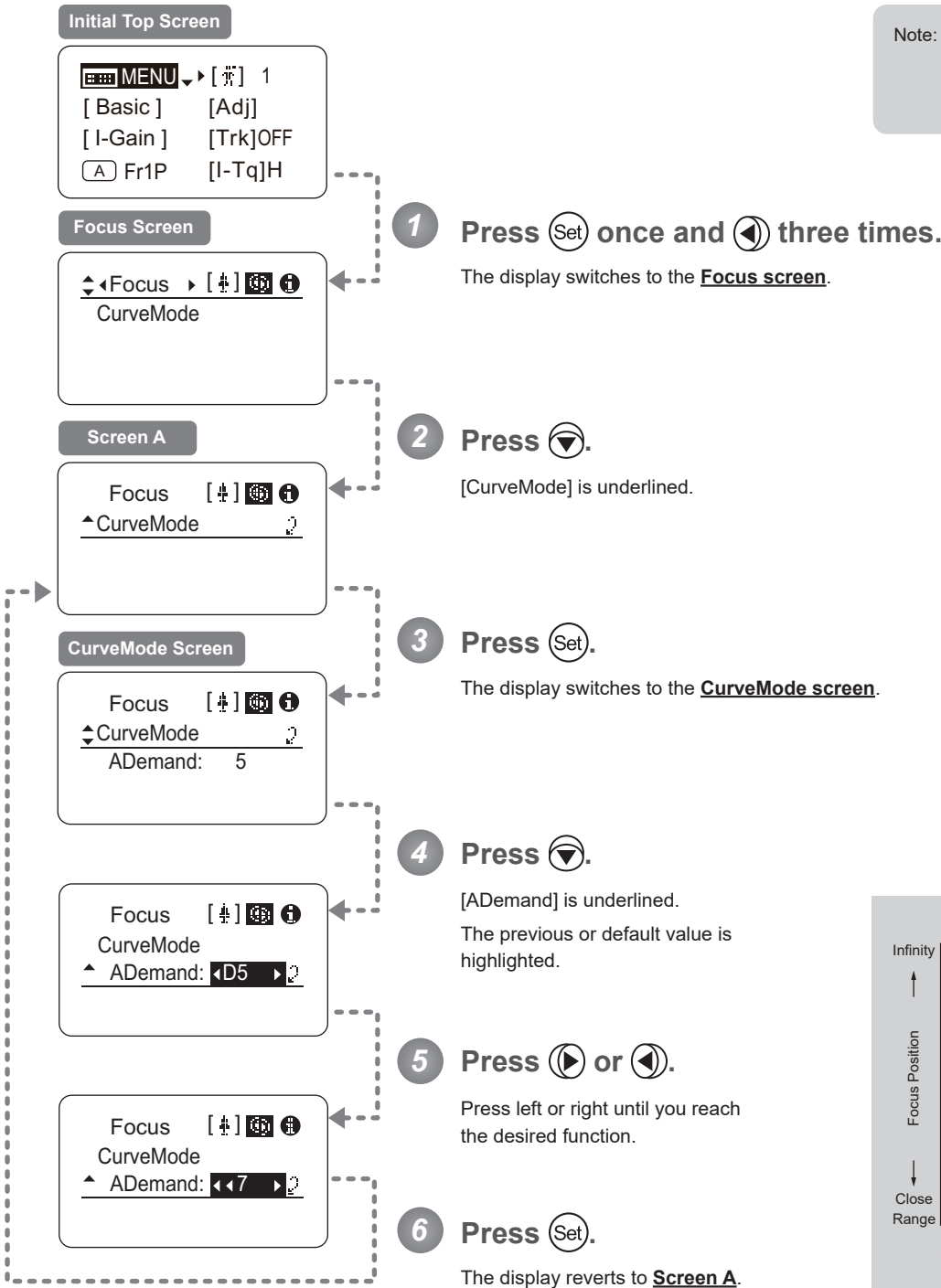

Options	1	to	9
Description	Large curve		Small curve

Default value: 5



4.2.7 Info Screen Settings

The following setting items can be configured on the **Info screen**.

Checking Serial Numbers

Specifying the 3D Function (For information on specifying the 3D function, see the instruction manual of the BC-100 3D cable.)

Specifying Encoder Output

Serial Communication with Camera ON/OFF

Specifying the Input Route for Command Signals from the Camera

Specifying the $\frac{1}{\lambda}$ Technology Distance Unit

Checking Lens–Drive Unit Communication

Configuring Settings in System Mode (Used by Canon Service Technicians Only)

Checking Serial Numbers

Check lens and drive unit serial numbers as needed.

Initial Top Screen

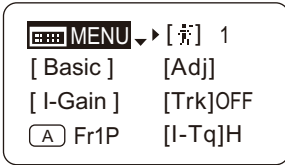

1 Press **Set** once and **◀** twice.

The display switches to the **Info screen**.

Info Screen

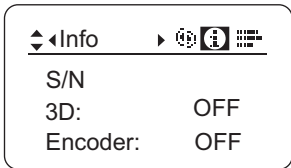

2 Press **▼**.

[S/N] is underlined.

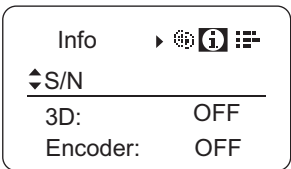

3 Press **Set**.

The lens and drive unit serial numbers are displayed.

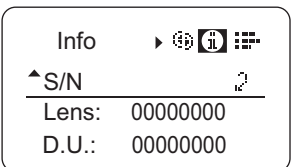

Note: The serial number of the lens is not displayed when no power is being supplied to the lens from the camera mount.



Specifying Encoder Output

Enable or disable encoder output as needed. Enabling output enables virtual connector output. For details, contact Canon or your dealer.

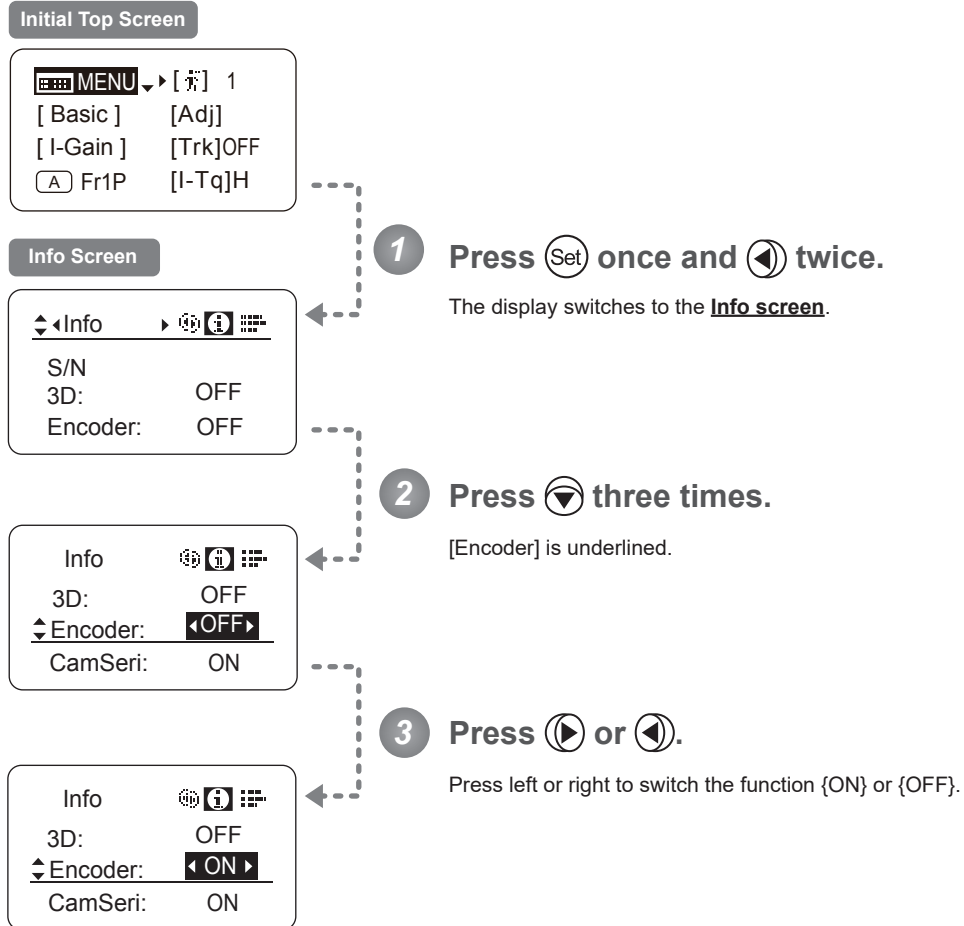

Options	^(D) OFF	ON
Description	Output disabled	Output enabled

(D): Default value



Serial Communication with Camera ON/OFF

Two types of camera–lens interfaces are available: analog control or control via serial communication. This setting enables you to switch between auto control detection and analog control.

By default, this setting is ON, enabling auto detection of whether serial or analog control is used.

To restrict the interface to analog control, set it to OFF.

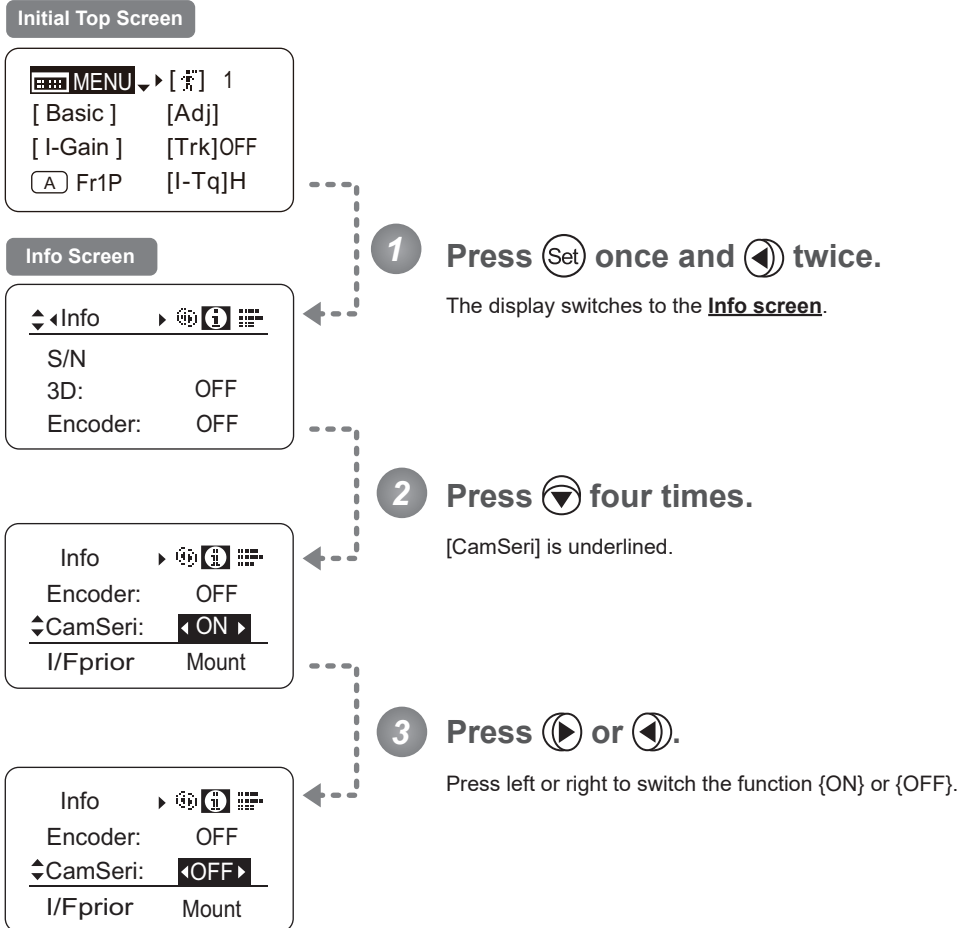

Options	^(D) ON	OFF
Description	Serial communication with the camera Enabled	Serial communication with the camera Disabled

(D): Default value

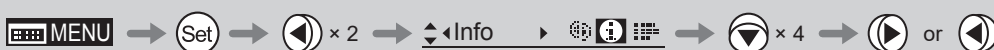

Specifying the Input Route for Command Signals from the Camera

There are two input routes for command signals from the camera: via the mount and via the 12-pin cable. This setting specifies the input route for command signals from the camera. The default setting is "Mount," and in this case command signals received via the mount are given priority.

However, the command signals via the 12-pin cable are received automatically if no command signals are input via the mount. When the "Cable" setting is selected, only command signals received via the 12-pin cable are used.

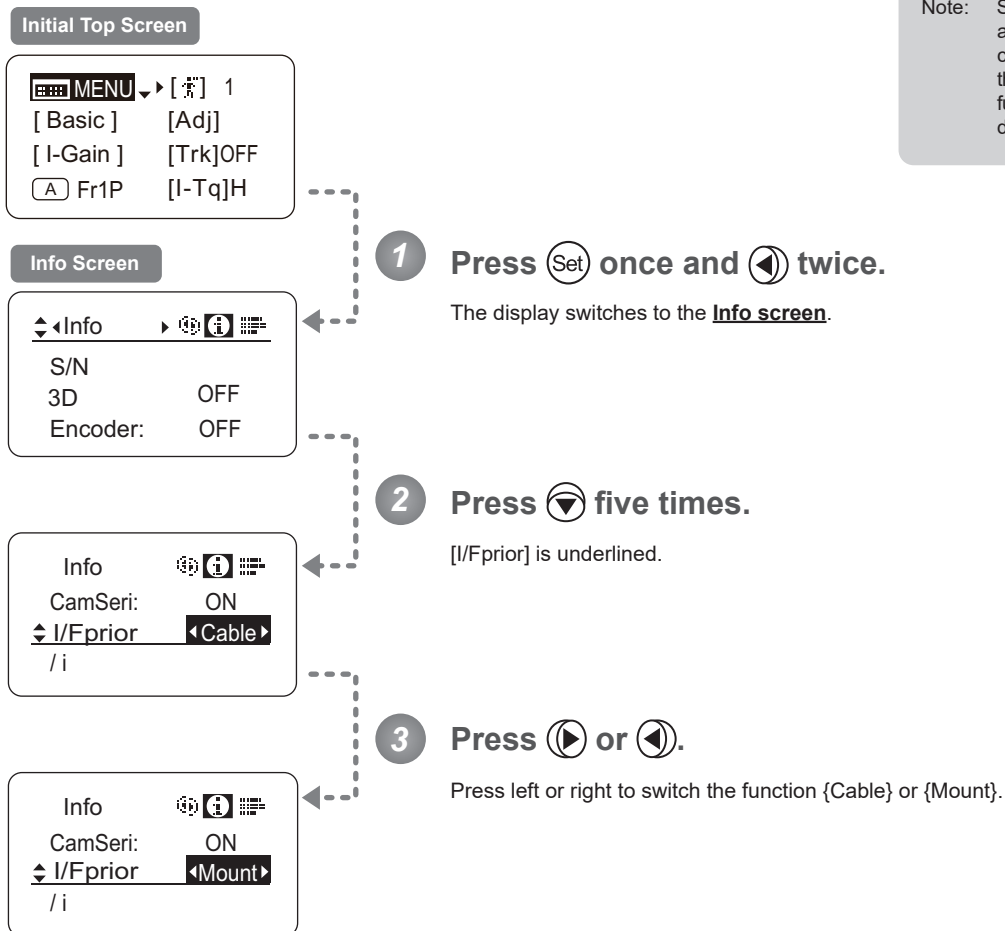

Note: Set {Mount} when using the auto focus function of the camera. (For the camera models that support the auto focus function, contact your Canon dealer.)

Options	^(D) Mount	Cable
Description	Via mount	Via 12-pin cable

(D): Default value

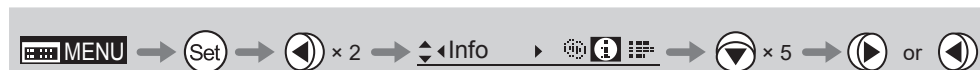

Specifying the $\frac{1}{i}$ Technology Distance Unit

When $\frac{1}{i}$ Technology is used (only when a PL mount camera is attached), it is possible to specify the initial setting for the unit (feet or meters) used to express distances in information sent to the camera. Accordingly, information sent for the actual subject distance, hyperfocal distance, subject distance at close range and infinity, and entrance pupil position is expressed in the specified unit.

Note

Any distance unit set on the camera takes precedence.

$\frac{1}{i}$ is trademark of Cooke Optics Limited.

Initial Top Screen

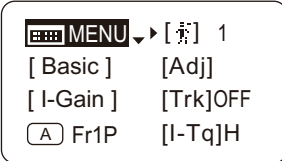

Info Screen

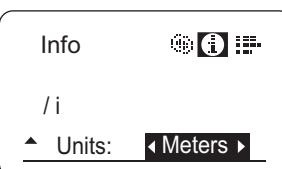
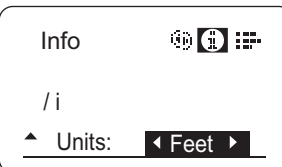
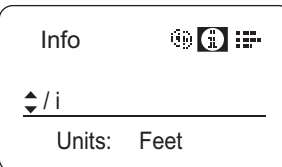
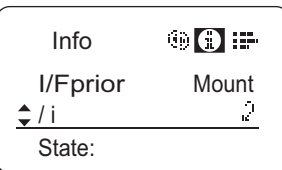
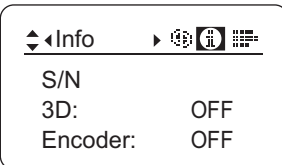

1 Press **Set** once and **Left Arrow** twice.

The display switches to the **Info screen**.

2 Press **Down Arrow** six times.

[/ i] is underlined.

3 Press **Set**.

4 Press **Down Arrow**.

[Units] is underlined.

The previous or default value is highlighted.

5 Press **Right Arrow** or **Left Arrow**.

Press left or right to switch the function {Feet} or {Meters}.

Options	^(D) Feet	Meters
Description	Expressed in feet	Expressed in meters

(D): Default value

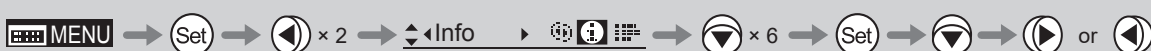

Checking Lens–Drive Unit Communication

View the status of communication between the lens and drive unit as follows.

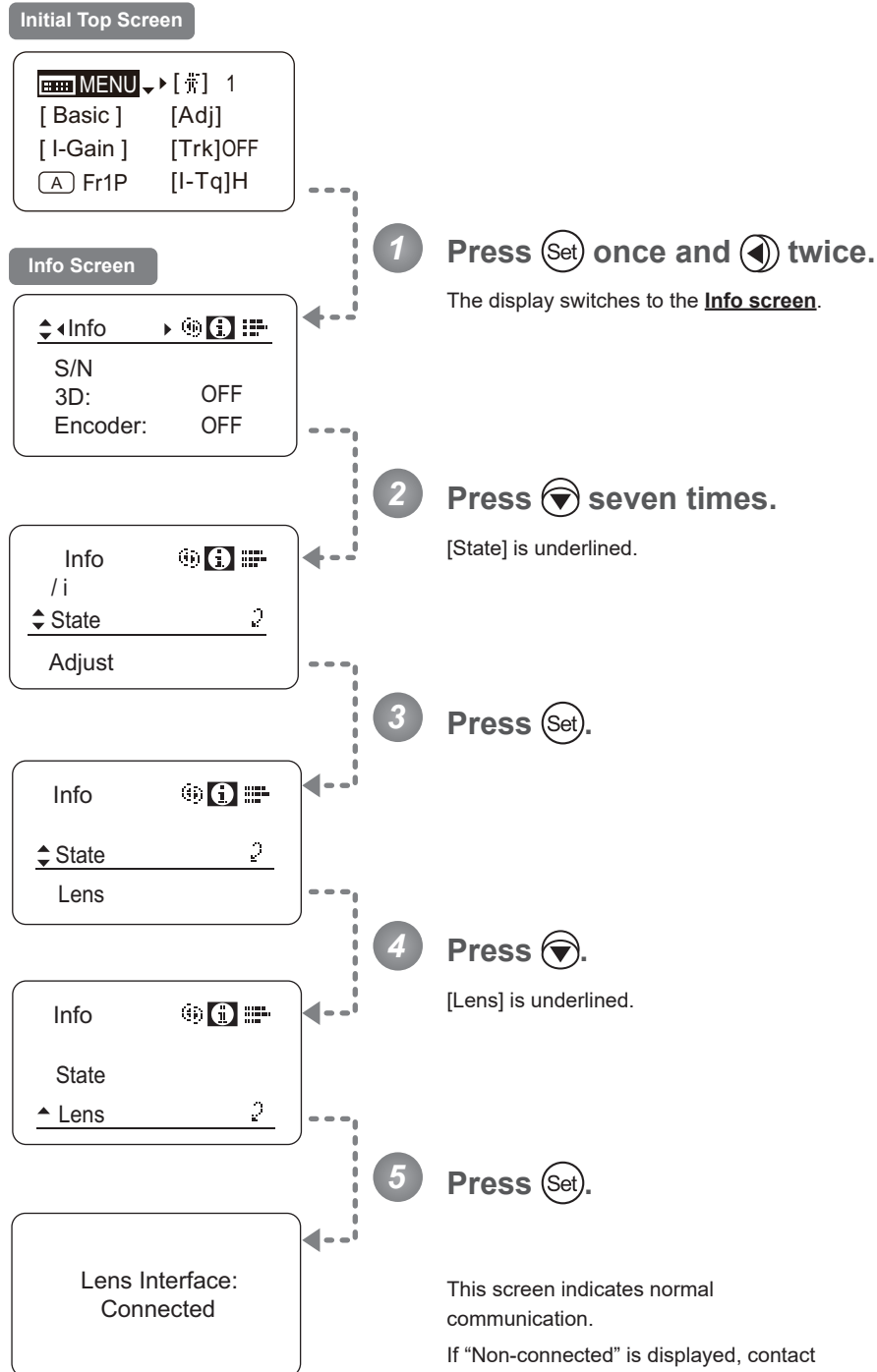

4.2.8 Fol. Screen Settings

The following setting items can be configured on the **Fol. screen**.

Viewing Lens Follow Settings (Iris, Zoom, Focus)

Viewing Lens Follow Settings (Iris, Zoom, Focus)

Indicates values in the full range of mechanical iris, zoom, and focus operations, expressed as relative values in the range of 0–1000.

Initial Top Screen

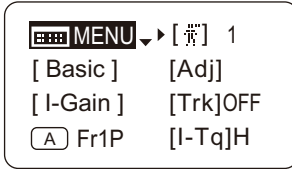

Fol. Screen

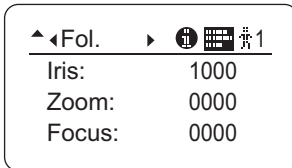

1 Press **Set** and then **◀**.

The display switches to the **Fol. screen**, showing relative follow iris, zoom, and focus values.

Note: As long as the **Fol. screen** is shown, the display will not turn off automatically after 2 minutes if left idle. To turn off the display, press the Display switch.



4.3 List of Settings

	Default Value	Options
To *1 on the next page		
MENU		
[]	1	1 / 2 / 3 / 4 / 5 / 6 / 7 / 8 / 9 / 0
[Basic]	Basic	Basic
[Adj]	n	n / y
[I-Gain]		
To *2 on the next page		
[Trk]	OFF	OFF / ON
(A)	Fr1P	VTR / RET / Fr1P / Fr1F / Fr2P / Fr2F / Sped / Shtl / NON
[I-Tq]	H	H / L
(A 1)	Shtl	VTR / RET / Fr1P / Fr1F / Fr2P / Fr2F / Sped / Shtl / NON
(V)	VTR	VTR / RET / Fr1P / Fr1F / Fr2P / Fr2F / Sped / Shtl
(A 2)	Fr1P	VTR / RET / Fr1P / Fr1F / Fr2P / Fr2F / Sped / Shtl / NON
(R)	RET	VTR / RET / Fr1P / Fr1F / Fr2P / Fr2F / Sped / Shtl
[Z.M.]		
To *3 on the next page		
()	Zoom	Zoom / Iris
(AM)	Norm	Norm / Reve / Auto / Manu
Escape Operation	Jump to user 0 setting status	Hold down both the Display switch and Set key for at least 2 seconds.

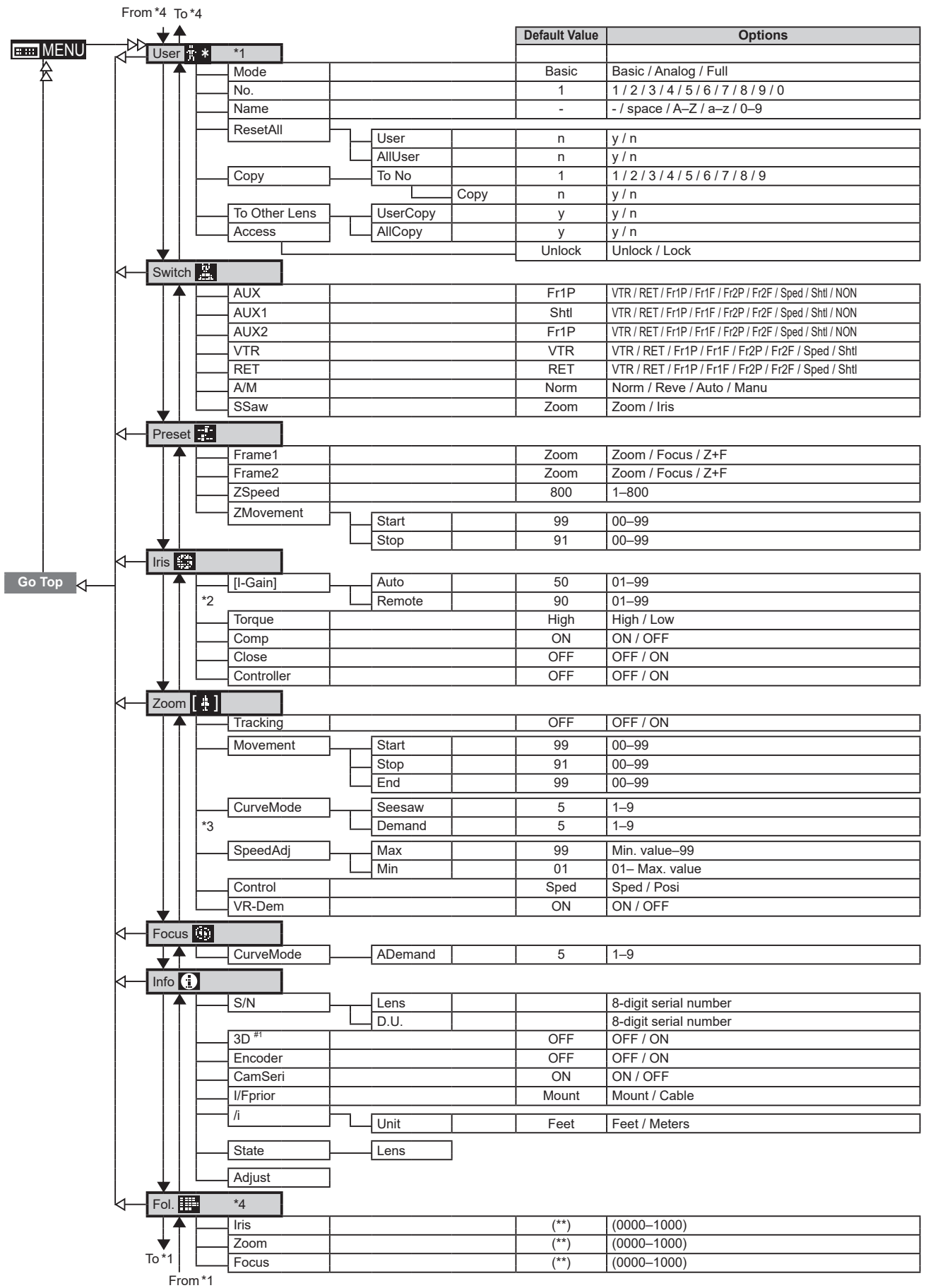

⏪ : Set key operation	⏩ : Right key operation	() : Indicates values that cannot be changed.
⏴ : Up key operation	⏵ : Left key operation	#1 : For information on specifying the 3D communication, see the "3D Cable Instruction Manual."

Memo

5

Operation in Analog Mode

5. Operation in Analog Mode

5.1 Configuration from the Top Screen

To access the **Top screen**, press the Display switch.

A total of 3 items can be configured on the **Top screen** in Analog mode. The first screen displayed is referred to as the **Initial Top screen**. Status of some items can be checked simply by accessing this screen.

Initial Top Screen in Analog Mode



⌨ MENU ▾ ▶ IG: 50
[Basic]

5.1.1 Selecting Analog Mode

Basic mode is the default mode, but Analog mode can be accessed as follows.

Use this mode for operation of a conventional analog drive unit. Digital functions are not available in this mode.

- Switches labeled VTR, RET, IRIS A/M, and IRIS INST control the respective functions. The rocker switch serves as a regular zoom switch.
- AUX and MEMO switches are disabled.
- To set auto iris gain adjustment, use either display or trimmer operations.
- Shuttle shot, frame preset, speed preset, and zoom tracking are not available.

Switching from Basic to Analog Mode

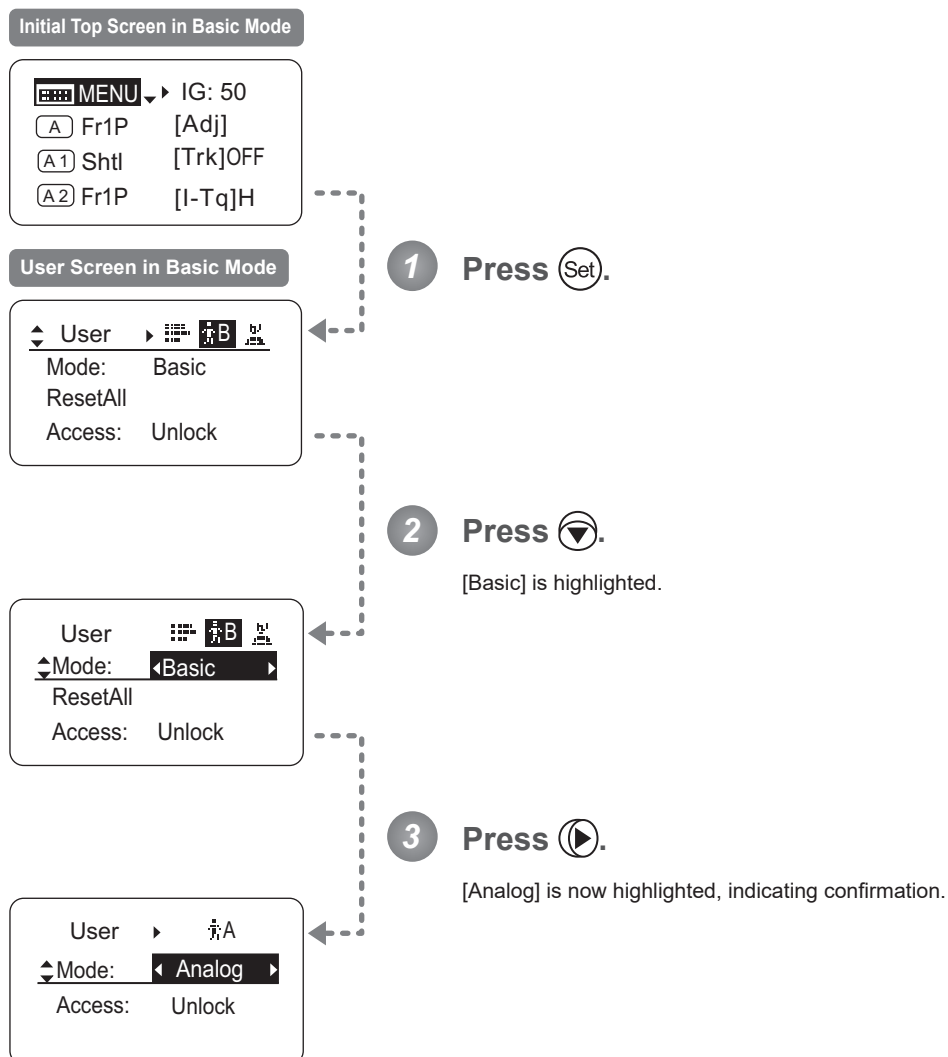

5.1.2 Top Screen

A total of 3 items can be configured on the **Top screen** in Analog mode, as shown on the **Initial Top screen**. Status of some items can be checked simply by accessing this screen. (Shown in the figure below.^{*1})

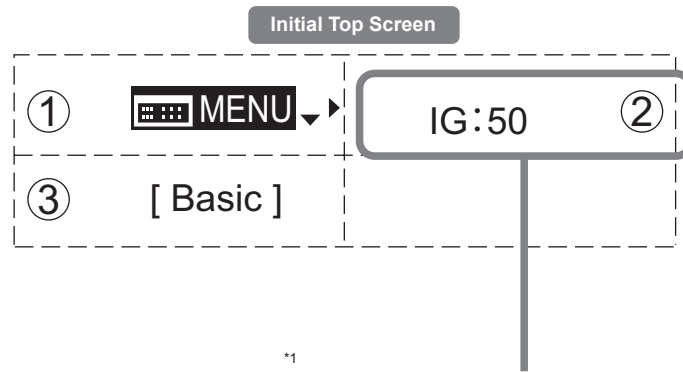

*1

Inside : Items that show the current setting status.
Example: [IG:50] indicates a value of 50 for auto iris gain.

① Menu screen

See "5.2 Configuration from the Menu Screen."

② IG Auto iris gain

Adjust the auto iris gain value as needed.

See "5.1.3 Specifying Auto Iris Gain."

③ [Basic] Switching to Basic Mode

Switch to Basic mode as needed.

See "5.1.4 Switching to Basic Mode."

5.1.3 Specifying Auto Iris Gain

[IG]

Although this value is factory-set, it can be adjusted as needed.

To adjust the value, use either the auto iris gain adjustment trimmer (refer to the operation manual "Lens") or display operations. Regardless of the method of adjustment used, the most recent setting takes precedence.

The same auto iris gain value applies to all users.

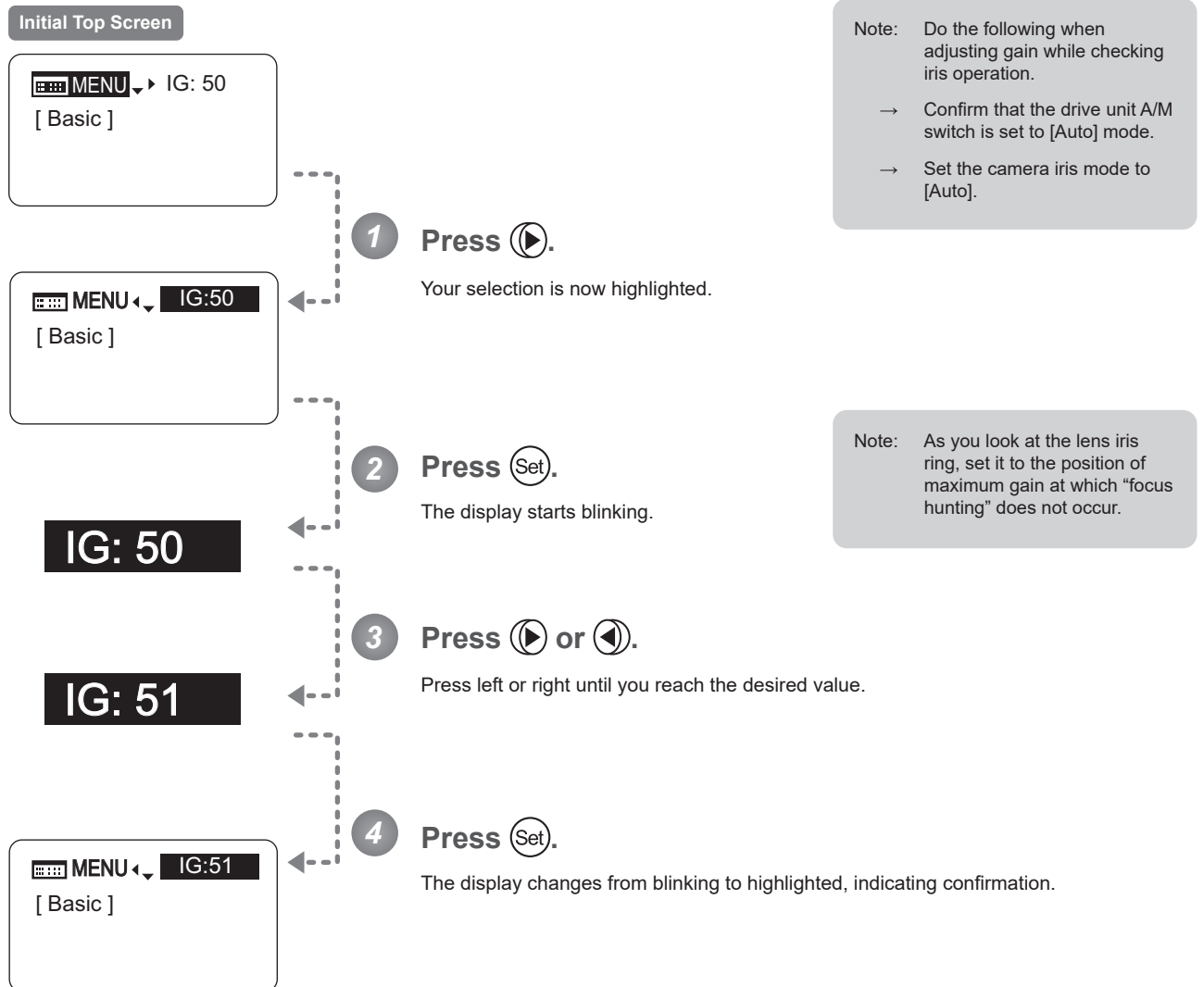

Options	01	to	99
Description	Minimum gain		Maximum gain

Default: Varies depending on the factory-set value, but corresponds to the value determined with the iris gain adjustment trimmer.



5.1.4 Switching to Basic Mode

[Basic]

Switch to Basic mode from the **Top screen** as needed.

Switching from Analog to Basic Mode

Initial Top Screen in Analog Mode



- 1 Press . [Basic] is highlighted.



- 2 Press . The mode switches, and the **Initial Top screen** in Basic mode is displayed.

Initial Top Screen in Basic Mode

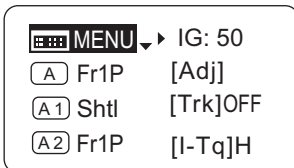

5.2 Configuration from the Menu Screen

In Analog mode, you can view and configure 2 setting items from the **Menu screen**.*

From the **Menu screen** in Analog mode, you can access a **User screen**.

Select [MENU] on the **Top screen** and press the Set key to access the **User screen**. (See the following figure.)

*: There is no single **Menu screen**. Instead, screens accessed by selecting [MENU] and pressing the Set key are collectively referred to as the **Menu screen**.

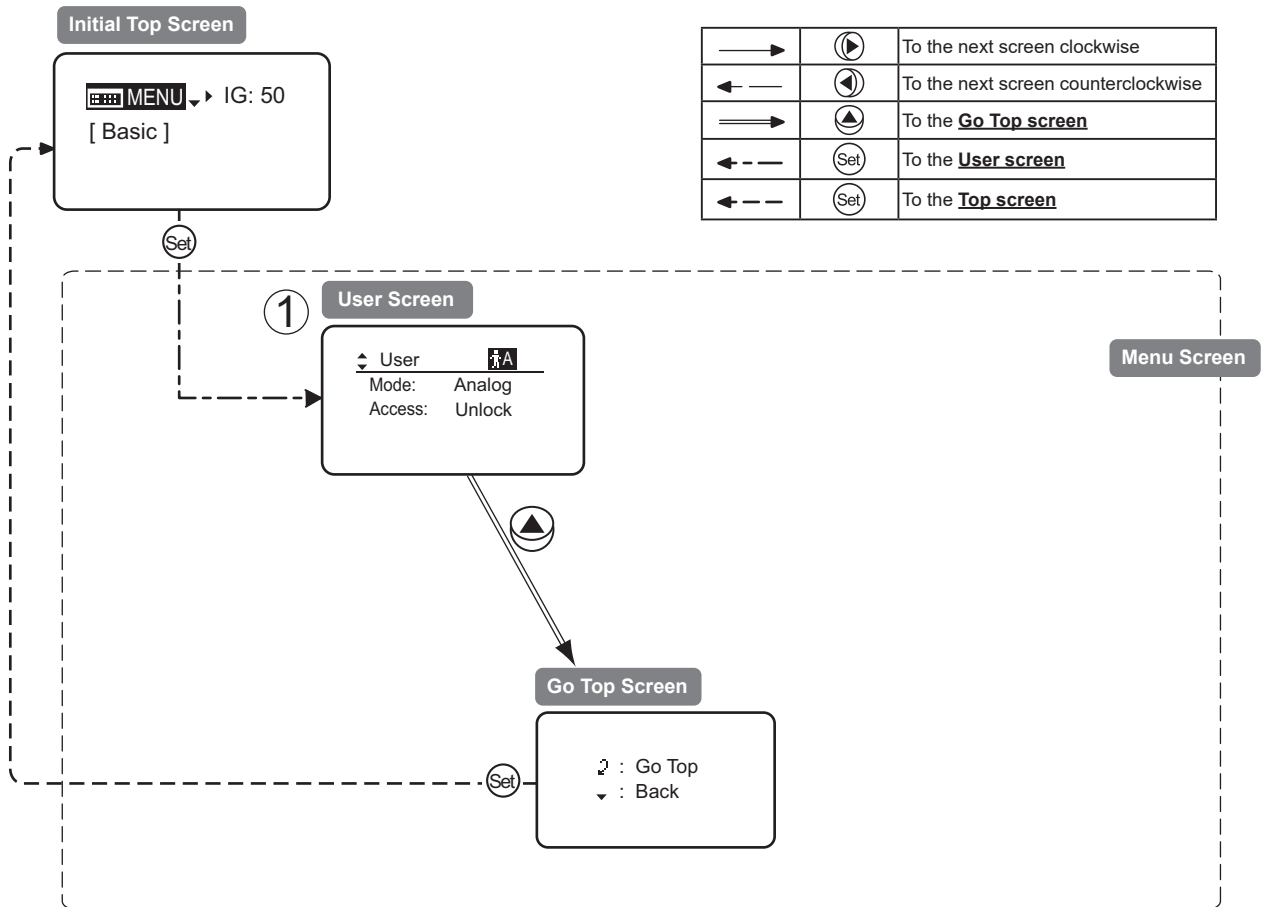

①	User Screen.....	5.2.1
---	------------------	-------

5.2.1 User Screen Settings

The following setting items can be configured on the **User screen**.

Switching Modes
Locking Functions

User Screen in Analog Mode

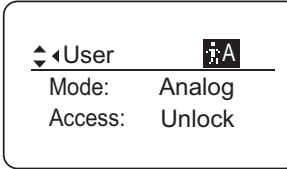

Switching Modes

Switch to Basic or Full mode, as needed.

Important

The new mode setting is retained even after the lens is turned off.

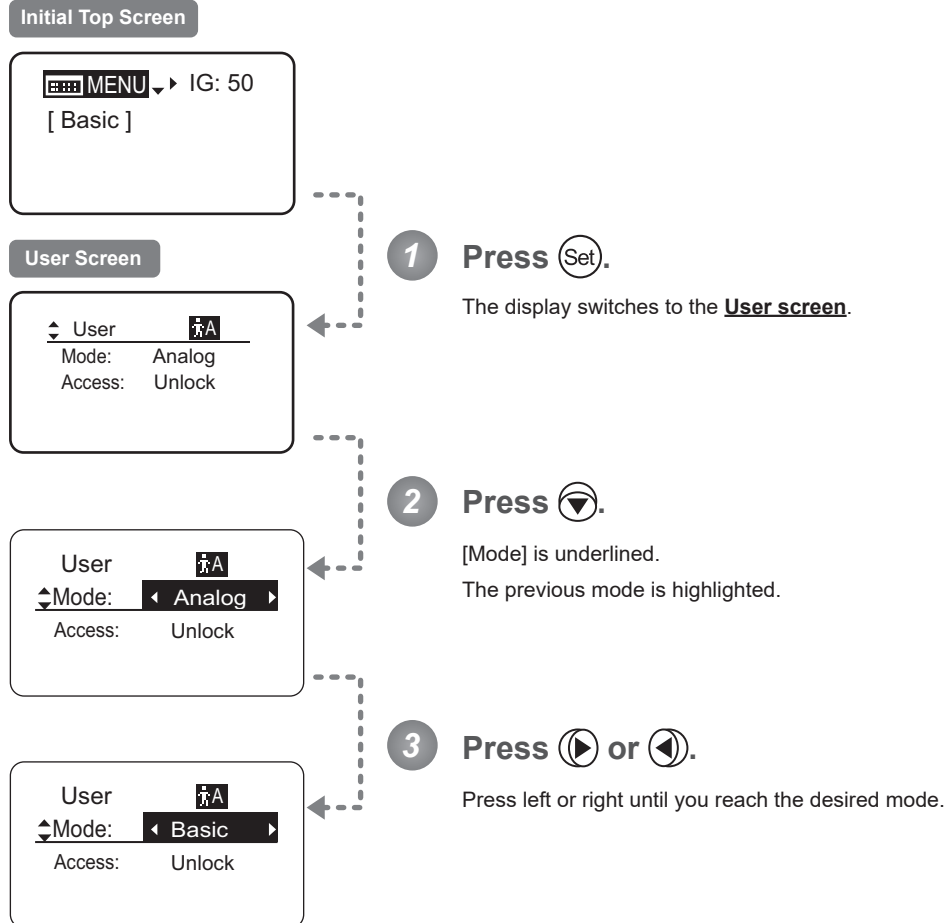

Options	^(D) Basic	Full	Analog
Save Settings	Basic Mode	Full Mode	Analog Mode

(D): Default value



Locking Functions

To ensure that configured functions cannot easily be changed, you can lock the settings of certain functions. Once functions are locked, they are locked for all users.

Two display operations are available in Analog mode: auto iris gain adjustment and user switching. However, you cannot switch users when functions are locked, because this function is also locked. Unlocking functions requires the password used to lock them.

(1) Locking Settings

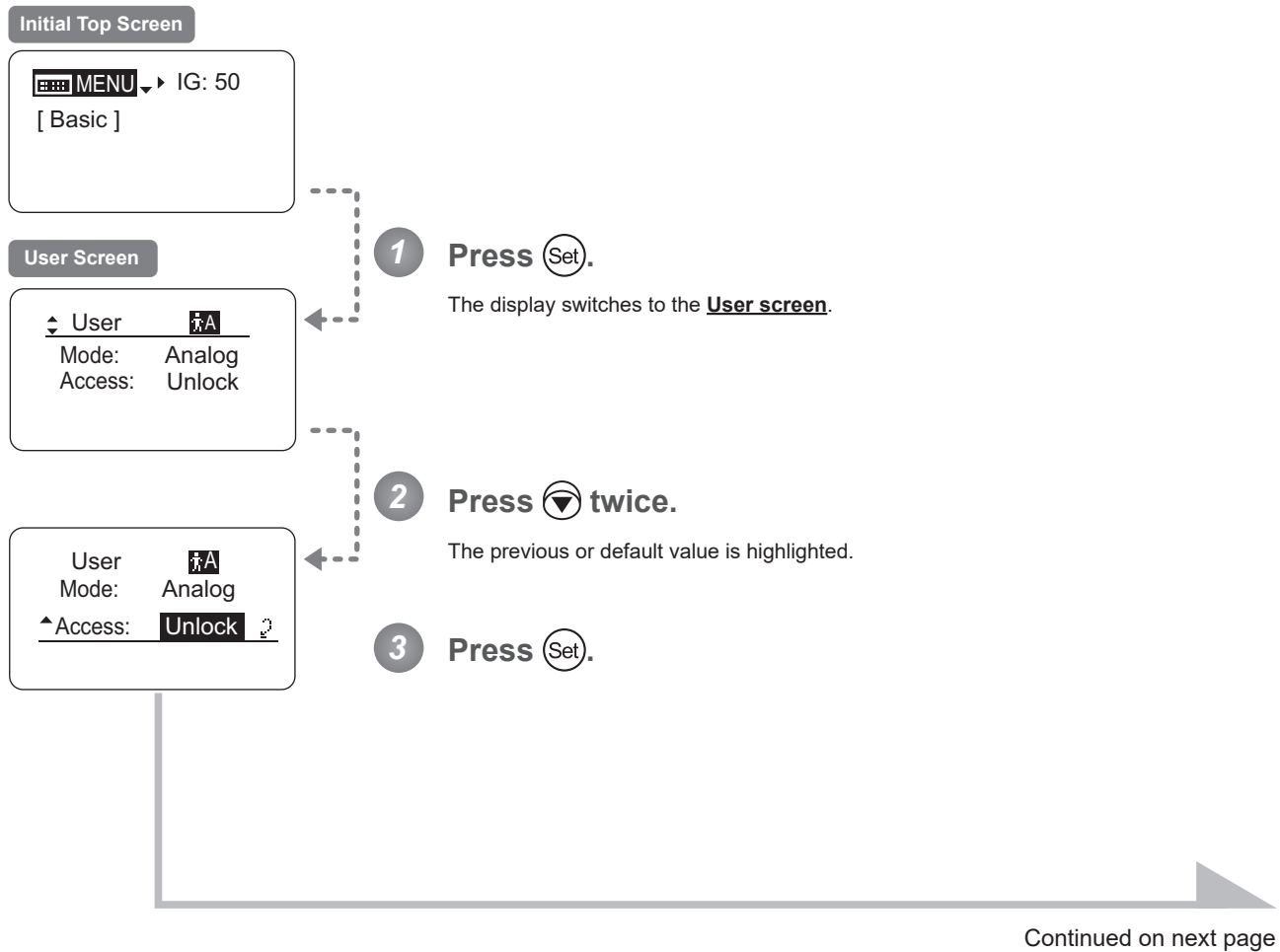

Continued on next page

Continued from previous page

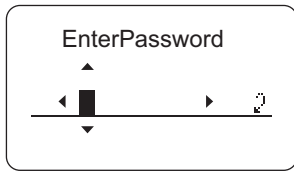

4 Enter the password and press (Set).

Entering Passwords

Press up/down to find characters and left/right to move the cursor or make corrections. Be careful not to press the Set key until you are finished entering the password.

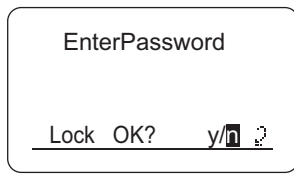

5 Press (Left Arrow) and then (Set).

The settings are now locked.

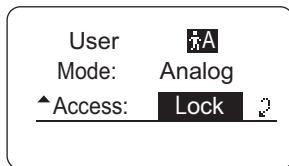

Note

Passwords

No master password is used on this model. The password you enter each time to lock settings is the password used to unlock them. For this reason, we recommend making a note of the password each time. If you forget the password, contact Canon or your dealer. Passwords can be blank or up to 8 digits.

Characters supported in passwords

Options	^(D) _-ABCDEFGHIJKLMN OPQRSTUVWXYZabcdefghijklmnopqrstuvwxyz0123456789
Max. Digits	8

(D): Default value
_ : Space

Options	^(D) Unlock	Lock
----------------	-----------------------	------

(D): Default value

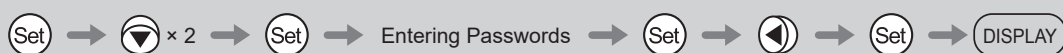

(2) Unlocking Settings

Initial Top Screen

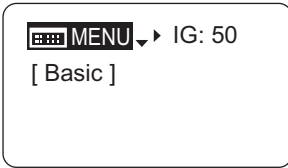

User Screen

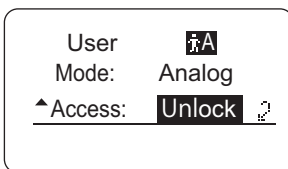
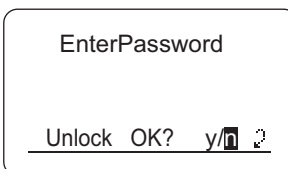
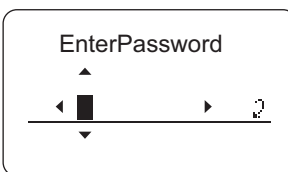
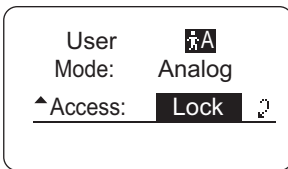
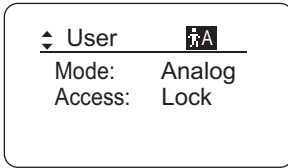

1 Press **Set**.

The display switches to the **User screen**.

2 Press **Down Arrow** twice.

The previous or default value is highlighted.

3 Press **Set**.

4 Enter the password and press **Set**.

Entering Passwords

Press up/down to find characters and left/right to move the cursor or make corrections. Be careful not to press the Set key until you are finished entering the password.

5 Press **Left Arrow** and then **Set**.

The settings are now unlocked.

Options	(D) Unlock	Lock
---------	------------	------

(D): Default value

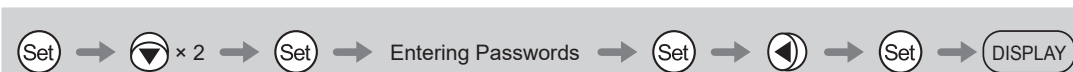

5.3 List of Settings

		Default Value	Options	Page
<div style="border: 1px solid black; padding: 2px; display: inline-block; margin-bottom: 5px;">Top</div> <div style="margin-left: 10px;"> <div style="border: 1px solid black; padding: 2px; display: inline-block; margin-bottom: 5px;">MENU</div> <div style="border: 1px solid black; padding: 2px; display: inline-block; margin-bottom: 5px;">IG</div> <div style="border: 1px solid black; padding: 2px; display: inline-block; margin-bottom: 5px;">[Basic]</div> </div>				
			To *1 on the next page	
		50	01-99	
			Basic	
Escape Operation	Jump to user 0 setting status	Hold down both the Display switch and Set key for at least 2 seconds.		

5. Operation in Analog Mode

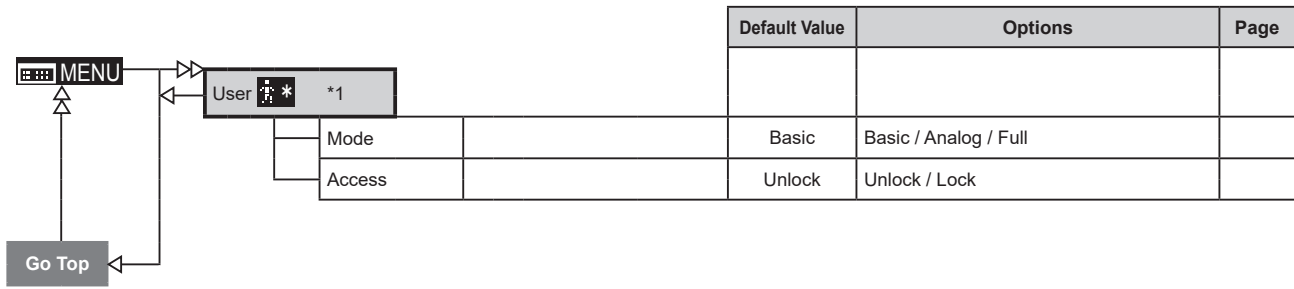

⏪ : Set key operation	⏩ : Right key operation
⏴ : Up key operation	⏴ : Left key operation

Memo



CANON INC.

30-2, Shimomaruko 3-chome, Ohta-ku, Tokyo, 146-8501, Japan